

# KENWOOD

DVD-RECEIVER

## KDV-412

---

## INSTRUCTION MANUAL

Kenwood Corporation



**Take the time to read through this instruction manual.**

**Familiarity with installation and operation procedures will help you obtain the best performance from your new DVD-receiver.**

**For your records**

Record the serial number, found on the back of the unit, in the spaces designated on the warranty card, and in the space provided below. Refer to the model and serial numbers whenever you call upon your Kenwood dealer for information or service on the product.

Model KDV-412 Serial number \_\_\_\_\_

**US Residence Only**

**Register Online**

Register your Kenwood product at  
**[www.Kenwoodusa.com](http://www.Kenwoodusa.com)**

# Contents

<b>How to read this manual</b>	<b>4</b>
<b>Safety precautions</b>	<b>7</b>
<b>Notes</b>	<b>8</b>
<b>Handling media</b>	<b>11</b>

<b>Watching DVD/VCD/Video files</b>	<b>20</b>
Frame-by-frame playback	20
Repeat play	20
Changing audio channel (Only for VCD)	21
Changing sound track language (Only for DVD)	21
Changing subtitle language (Only for DVD)	21
Changing viewing angle (Only for DVD)	21
Zoom	22
DVD menu (Only for DVD)	22
PBC setup (Only for VCD)	23

<b>DVD setup</b>	<b>24</b>
Monitor display setup	24
Audio setup	25
CD player setup	26
DVD player setup	26
Language setup	28
Parental level setup/change	29

<b>Listening to Music Discs &amp; Audio Files</b>	<b>30</b>
Disc/Folder search (Only for audio files and disc changers)	30
Repeat play	30
Scan play	30
Random play	31
Magazine random play (Only for disc changer)	31
Title/Text scroll	31

<b>Audio Control</b>	<b>40</b>
Detailed audio control	40
Audio setup	40
Speaker setup	41
System Q	42
Subwoofer output control	42

<b>Basic Operations</b>	<b>12</b>
Common operations	12
Watching DVD/VCD (video CD)/ Video (MPEG) files	14
Listening to CDs and audio files	16
Viewing picture (JPEG) files	18
Listening to radio	19

<b>Select Mode</b>	<b>32</b>
Select mode	32
File select	32
Folder select 1	33
Folder select 2	33

<b>Watching picture files</b>	<b>34</b>
Repeat play	34
Scan play	34
Random play	35
Stop display	35
Rotate/flip a picture	35

<b>Listening to Radio</b>	<b>36</b>
Auto memory	36
Manual memory	36
Tuning mode	37

<b>RDS Control</b>	<b>38</b>
PTY (Program Type)	38
Registration of a station as a PTY	39
Program Type Preset	39
Radio Text Scroll	39

<b>TEL Mute Control</b>	<b>43</b>
TEL Mute	43

<b>HD Radio Control</b>	<b>57</b>
About HD Radio	57
Tuning	57

<b>Display Control</b>	<b>44</b>
Selecting display information	44
Monitor information display & file selection	46
Removing operation panel	47
Installing operation panel	47

<b>Menu</b>	<b>48</b>
Menu setup	48
Setting security code	50
Clearing security code	50
Security code entry	51
Adjusting the clock	52
HD Radio Receive mode setting	52
AUX name select	53
Demonstration setup	54
Audio preset	54
Recalling audio preset values	55
T.I (Traffic Information)	56

<b>Remote Controller</b>	<b>58</b>
Battery installation	58
Remote Controller mode switch	58
Common operations (AUD mode)	59
DVD/VCD/CD/Audio files (DVD mode)	60
Radio (AUD mode)	61

<b>Help? Playing files</b>	<b>62</b>
Audio files	62
Video files	64
Picture files	64
<b>Help? Troubleshooting</b>	<b>65</b>
General	65
Playing discs	66
Audio files	67
HD Radio source	67
Menu	67
<b>Help? Term</b>	<b>68</b>
General	68
Audio control	68
Menu	69
<b>Help? Error</b>	<b>71</b>

<b>DVD language codes</b>	<b>72</b>
<b>Accessories/ Installation Procedure</b>	<b>73</b>
<b>Connections</b>	<b>74</b>
<b>Installation</b>	<b>76</b>
<b>Specifications</b>	<b>78</b>

**How to read this manual**  
**Safety precautions**  
**Notes**  
**Handling media**

**Basic Operation**

**Watching DVD/VCD/Video files**

**DVD setup**

**Listening to Music Discs & Audio Files**

**Select Mode**

**Watching picture files**

**Listening to Radio**

**RDS Control**

**Audio Control**

**TEL Mute Control**

**Display Control**

**Menu**

**HD Radio Control**

**Remote Controller**

**Help?**

**DVD language codes**  
**Accessories**  
**Connections**  
**Installation**

# How to read this manual

This manual uses illustrations to explain its operations.

The displays and panels shown in this manual are examples used to provide clear explanations of the operations. For this reason, they may be different from the actual displays or panels used, or some display patterns may be different.

## Moving the control knob

The following figure shows how to use the knob.

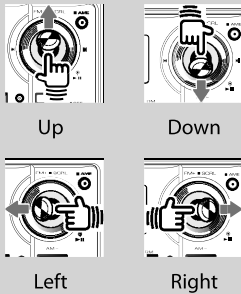

How to turn the volume is shown in the following figure.

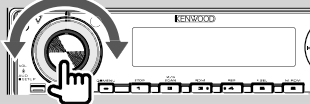

▼ : Continues to the next line.  
● : Ends here.

## Tuning mode



Sets a tuning mode for selecting stations.

### 1 Set to the menu mode

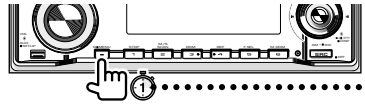

### 2 Select a tuning mode

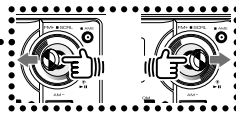

There are three types in the tuning mode.

Display	Setting
AUTO1	Receives stations with the best reception. (Auto 1)
AUTO2	Receives the stations memorized. (Auto 2)
MANUAL	Switches the receiving frequencies up and down at a step at a time. (Manual)

### 3 Display the CD player menu

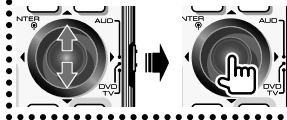
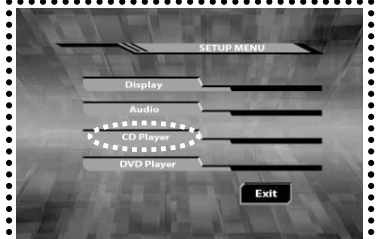

### 4 Exit the menu mode

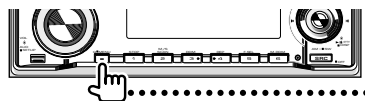

The above operation example with the mark differs from the actual operation.

### Remote controller operation

Some functions can only be used from a remote controller. In this case, the operation using the remote controller is described, showing a  mark.

The characters below indicate a remote controller mode switch setting.

### Display indication

Perform the operation shown on the left until this screen appears.

### Change in the screen

With each operation, the screen changes in the order shown here.

### Selecting a screen item

Select and choose an item on the screen. Select the item enclosed with  on the screen by pressing the cursor key on the remote controller, and press the ENTER key.

### Short Press

Press the button, denoted by .

### Press 1 second or more

Press the button, denoted by , for 1 second or more (2-3 seconds).

Indicates to press and hold down the button until operation starts or the screen changes.

The left example indicates to press the button for 1 second.

Press it approximately for the seconds shown in the clock.

### Other marks



Important precautions are described to prevent injuries etc.



Special instructions, supplementary explanations, limitations, and reference pages are described.



General precautions and reference pages are shown on the item.

"DTS" and "DTS 2.0 + Digital Out" are trademarks of Digital Theater Systems, Inc.

Manufactured under license from Dolby Laboratories. "Dolby" and the double-D symbol are trademarks of Dolby Laboratories.

**DVD** is a trademark of DVD Format/Logo Licensing Corporation registered in the U.S., Japan and other countries.

This product incorporates copyright protection technology that is protected by U.S. patents and other intellectual property rights. Use of this copyright protection technology must be authorized by Macrovision, and is intended for home and other limited viewing uses only unless otherwise authorized by Macrovision. Reverse engineering or disassembly is prohibited.

## **▲CAUTION**

Use of controls or adjustments or performance of procedures other than those specified herein may result in hazardous radiation exposure.

In compliance with Federal Regulations, following are reproductions of labels on, or inside the product relating to laser product safety.

KENWOOD CORPORATION  
2967-3, ISHIKAWA-MACHI,  
HACHIOJI-SHI  
TOKYO, JAPAN

KENWOOD CORP. CERTIFIES THIS EQUIPMENT  
CONFORMS TO DHHS REGULATIONS NO.21 CFR  
1040. 10, CHAPTER 1, SUBCHAPTER J.

Location : Bottom Panel

## **NOTE**

This Class B digital apparatus complies with Canadian ICES-003.

## **FCC WARNING**

This equipment may generate or use radio frequency energy. Changes or modifications to this equipment may cause harmful interference unless the modifications are expressly approved in the instruction manual. The user could lose the authority to operate this equipment if an unauthorized change or modification is made.

## **NOTE**

This equipment has been tested and found to comply with the limits for a Class B digital device, pursuant to Part 15 of the FCC Rules. These limits are designed to provide reasonable protection against harmful interference in a residential installation. This equipment may cause harmful interference to radio communications, if it is not installed and used in accordance with the instructions. However, there is no guarantee that interference will not occur in a particular installation. If this equipment does cause harmful interference to radio or television reception, which can be determined by turning the equipment off and on, the user is encouraged to try to correct the interference by one or more of the following measures:

- Reorient or relocate the receiving antenna.
- Increase the separation between the equipment and receiver.
- Connect the equipment into an outlet on a circuit different from that to which the receiver is connected.
- Consult the dealer or an experienced radio/TV technician for help.

# Safety precautions

## **▲WARNING**

### **To prevent injury or fire, take the following precautions:**

- To prevent a short circuit, never put or leave any metallic objects (such as coins or metal tools) inside the unit.
- Mounting and wiring this product requires skills and experience. For safety's sake, leave the mounting and wiring work to professionals.

### **Attach the panel while you are on the vehicle**

The panel lock arm appears when the panel is removed. Therefore, the panel must be attached while the electrical system of the car is operating.

## **▲CAUTION**

### **To prevent damage to the machine, take the following precautions:**

- Make sure to ground the unit to a negative 12V DC power supply.
- Do not install the unit in a spot exposed to direct sunlight or excessive heat or humidity. Also avoid places with too much dust or the possibility of water splashing.
- Do not place the faceplate (and the faceplate case) in areas exposed to direct sunlight, excessive heat or humidity. Also avoid places with too much dust or the possibility of water splashing.
- To prevent deterioration, do not touch the terminals of the unit or faceplate with your fingers.
- Do not subject the faceplate to excessive shock, as it is a piece of precision equipment.
- When replacing a fuse, only use a new fuse with the prescribed rating. Using a fuse with the wrong rating may cause your unit to malfunction.
- Do not apply excessive force to the open faceplate or place objects on it. Doing so will cause damage or breakdown.
- Do not use your own screws. Use only the screws provided. If you use the wrong screws, you could damage the unit.

### **About CD players/disc changers connected to this unit**

Kenwood disc changers/CD players released in 1998 or later can be connected to this unit. Refer to the catalog or consult your Kenwood dealer for connectable models of disc changers/CD players. Note that any Kenwood disc changers/CD players released in 1997 or earlier and disc changers made by other makers cannot be connected to this unit. Connecting unsupported disc changers/CD players to this unit may result in damage. Set the "O-N" Switch to the "N" position for the applicable Kenwood disc changers/CD players. The functions you can use and the information that can be displayed may differ depending on the models being connected.



- You can damage both your unit and the CD changer if you connect them incorrectly.

### **Lens Fogging**

When you turn on the car heater in cold weather, dew or condensation may form on the lens in the unit. Called lens fogging, this condensation on the lens may not allow DISC to play. In such a situation, remove the disc and wait for the condensation to evaporate. If the unit still does not operate normally after a while, consult your Kenwood dealer.

# Notes

- If you experience problems during installation, consult your Kenwood dealer.
- When you purchase optional accessories, check with your Kenwood dealer to make sure that they work with your model and in your area.
- If the unit fails to operate properly, press the Reset button. The unit returns to factory settings when the Reset button is pressed.
- Press the Reset button if the disc auto changer fails to operate correctly. Normal operation should be restored.

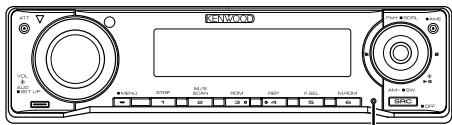

Reset button

- We recommend the use of <Setting security code> (page 50) to prevent theft.
- The characters which can be displayed by this unit are A-Z 0-9 @ ' ' % & \* + - = , . / \ < > [ ] ( ) ; : ^ - { } | ~ .
- The RDS feature won't work where the service is not supported by any broadcasting station.
- The illustrations of the display and the panel appearing in this manual are examples used to explain more clearly how the controls are used. Therefore, what appears on the display in the illustrations may differ from what appears on the display of the actual equipment, and some of the illustrations on the display may be inapplicable.

## Cleaning the Unit

If the faceplate of this unit is stained, wipe it with a dry soft cloth such as a silicon cloth.

If the faceplate is stained badly, wipe the stain off with a cloth moistened with neutral cleaner, then wipe it again with a clean soft dry cloth.



- Applying spray cleaner directly to the unit may affect its mechanical parts. Wiping the faceplate with a hard cloth or using a volatile liquid such as thinner or alcohol may scratch the surface or erase characters.

## Cleaning the Faceplate Terminals

If the terminals on the unit or faceplate get dirty, wipe them with a clean soft dry cloth.

## Before using this unit for the first time

This unit is initially set on the Demonstration mode. When using this unit for the first time, cancel the <Demonstration setup> (page 54).

## About SIRIUS Satellite radio tuner

Refer to the instruction manual of SIRIUS Satellite radio tuner KTC-SR901/SR902/SR903 (optional accessory), when connected, for the operation method.

- Refer to the sections of A models for operations.

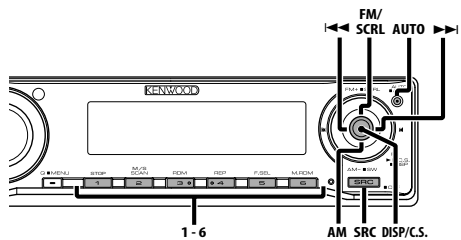

## About DAB Tuner control

Refer to [A] group on the Instruction manual of DAB Tuner KTC-9090DAB (optional accessory) for the control method of DAB Tuner function. However, the following control methods of the function for this unit may be different from the descriptions given in the Instruction manual; therefore, refer to the following supplemental instruction.

### <Auto Ensemble Memory Entry>

1. Select the preset band for Auto Ensemble Memory Entry.
2. Press the [AME] button for at least 2 seconds. Open Auto Ensemble Memory Entry. After storing in the memory is completed, the number of the pre-set buttons and the ensemble label are displayed.

### <Searching by programme type and language>

At the operation to press [DISP] button, use [AUTO] button instead.



## Region codes in the world

The DVD players are given a region code according to the country or area it is marketed, as shown in the following map.

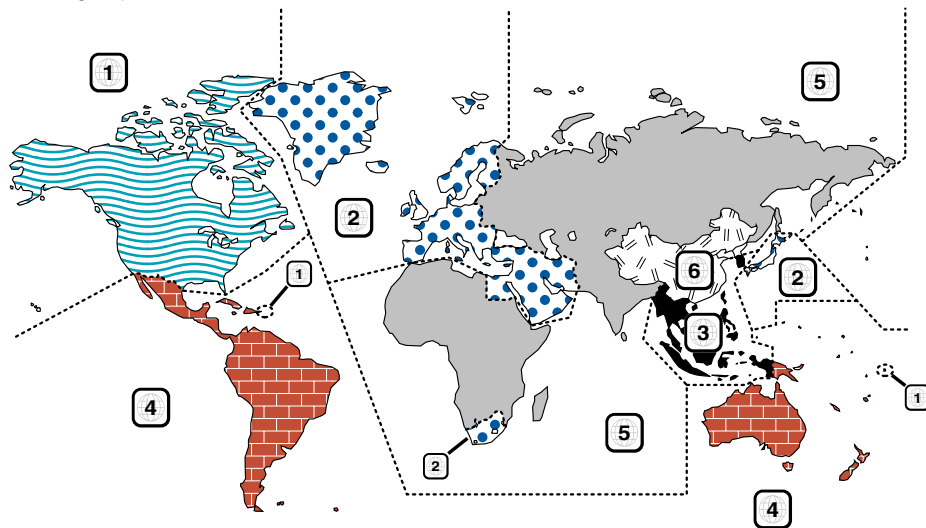

## DVD disc marks

Symbol	Description
	Indicates a region number. The discs with this mark can be played with any DVD player.
	Indicates the number of audio languages recorded. Up to 8 languages can be recorded in a movie. You can select a favorite language.
	Indicates the number of subtitled languages recorded. Up to 32 languages can be recorded.
	If a DVD disc has scenes shot from multiple angles, you can select a favorite angle.
	Indicates the type of screen for the image. The left mark indicates that a wide image picture (16:9) is displayed on a standard TV set screen (4:3) with a black band at both the top and bottom of the screen (letter box).

## Operation regulatory marks

With this DVD, some functions of this unit such as the play function may be restricted depending on the location where the DVD is playing. In this case, the following marks will appear on the screen. For more information, refer to the disc manual.

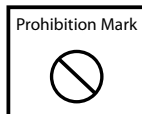

## Discs with limited period of use

Do not leave discs with a limited period of use in this unit. If you load an already expired disc, you may not be able to remove it from this unit.

## List of playable discs

Disc types	Standard	Support	Remark
DVD	DVD Video	○	
	DVD Audio	×	
	DVD-R	○	MP3/WMA/JPEG/MPEG Playback
	DVD-RW	○	VR mode/Multi-border/Multisession/CPRM not supported
	DVD+R	○	(Playback depends on authoring conditions)
	DVD+RW	○	Compatible with 8-cm (3 inch) discs
	DVD-R DL (Double layer)	×	
	DVD+R DL (Double layer)	×	
	DVD-RAM	×	
	CD	Music CD	○
	CD-ROM	○	MP3/WMA/JPEG playback
	CD-R	○	Multisession supported
	CD-RW	○	Packet write not supported.
	DTS-CD	○	
	Video CD (VCD)	○	
	Super video CD	×	
	Photo CD	×	
	CD-EXTRA	△	Only music CD session can be played.
	HDCD	△	Sound quality of normal CD music
	CCCD	×	
Others	Dualdisc	×	
	Super audio CD	△	Only CD layer can be played.

○ : Playback is possible.

△ : Playback is partly possible.

× : Playback is impossible.

## Use of "DualDisc"

When playing a "DualDisc" on this unit, the surface of the disc that is not played may be scratched while the disc is inserted or ejected. Since the music CD surface does not conform to the CD standard, playback may be impossible.

(A "DualDisc" is a disc with one surface containing DVD standard signals and the other surface containing music CD signals.)

# Handling media

## Handling discs

- Do not touch the recording surface of the disc.

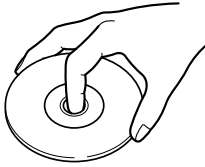

- CD-R/RW, DVD-R/RW, and DVD+R/RW discs are easier to be damaged than a ordinary music CD. Use a CD-R/RW, DVD-R/RW, or DVD+R/RW disc after reading the cautions on the package.
- Do not stick a tape, sticker, etc., on the disc. Also, do not use a disc with those materials pasted on it.

## When using a new disc

If the disc center hole or outside rim has burrs, use it after removing them with a ballpoint pen etc.

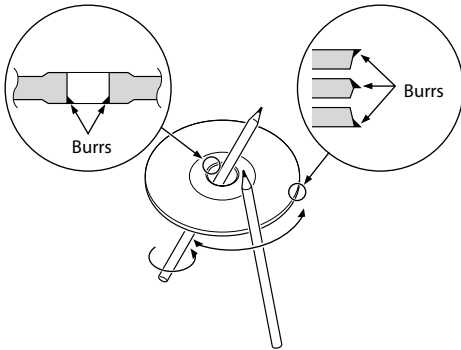

## Disc shaped accessory

Do not insert a disc shape accessory into the unit.

## Disc cleaning

Wipe from the center of the disc to outward.

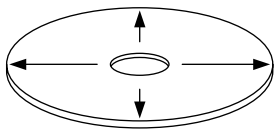



## Removing discs

When removing discs from this unit pull them out horizontally.

## Discs that can not be used

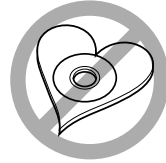
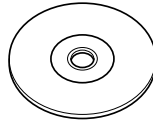
- Discs that are not round cannot be used.



- Discs with coloring on the recording surface or that are dirty cannot be used.
- This unit can only play the CDs with one of  labels. Discs without the label may not be played on the unit.
- A CD-R or CD-RW that hasn't been finalized cannot be played. (For the finalization process refer to your CD-R/CD-RW writing software, and your CD-R/CD-RW recorder instruction manual.)

## Disc storage

- Do not leave discs place them in direct sunlight (On the seat or dashboard etc.) and where the temperature is high.
- Put discs in their cases and store them in such a storage as disc cabinet.

## How to eject a disc

When ejecting a disc from this unit, pull it out horizontally.

If pulled out with a strong downward force, the recording surface of the disc may be scratched.

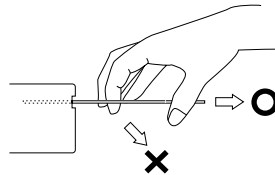

# Basic Operations

## Common operations

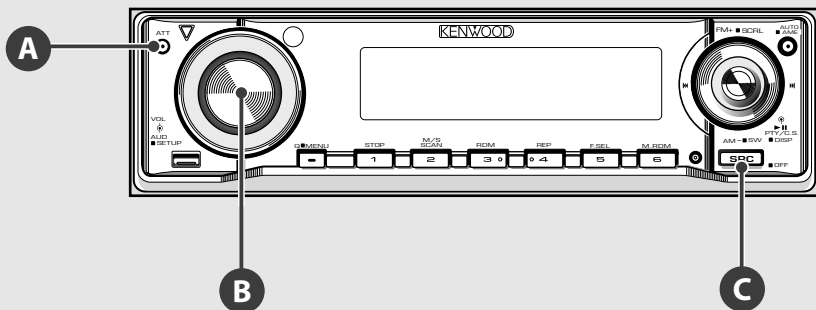

**C**

### Turns power ON/OFF

Press the button to turn on the power.  
When the button is pressed and held down for 1 second or more, the power is turned off.

**A**

### Turns down the volume quickly

Press the button to turn down the volume (Attenuator).  
Press the button again to restore the previous volume.



- While the attenuator is activated, the **ATT** indicator blinks.

**B**

### Adjusts audio output level

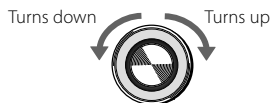

### Canceling demonstration mode

The demonstration mode should be canceled before use. For further information, refer to <Demonstration setup> (page 54).

C

## Changes a source

A playable source is selected in the following order each time the button is pressed.

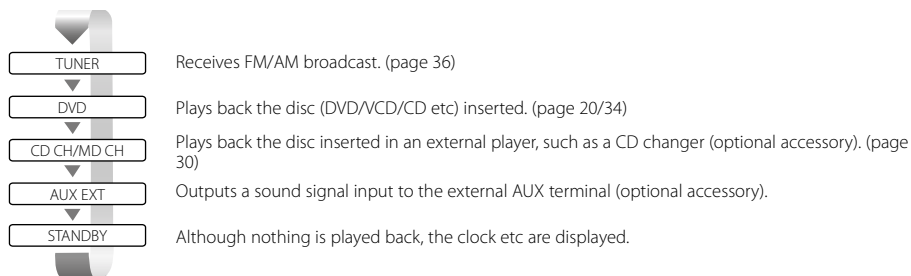

- If no CD/MD changer is connected, the changer source is not selected.
- When a disc is inserted, the disc is played.
- You can play audio files, video files and picture files with DVD source. For details of these media types, formatting or writing methods, refer to <Help? Playing files> (page 62).
- "AUX EXT" display using KCA-S220A can be switched with <AUX name select> (page 53).

B

## Adjusts sound quality and others

Push the knob to select the feature to be adjusted, and turn the knob clockwise/counterclockwise to adjust the feature.

Features are selected in the following order.

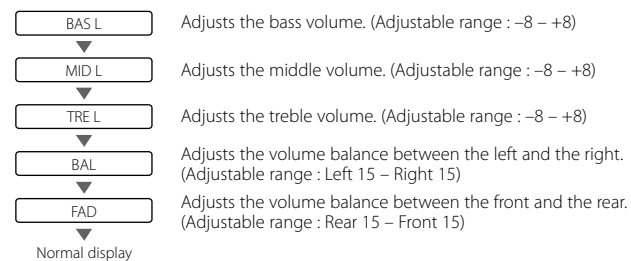

- The features displayed for sound quality adjustment may differ depending on the settings. Detailed setup is also possible. For further information, refer to <Detailed audio control> (page 40).
- You can easily adjust the sound quality to suit the type of music you are playing. For further information, refer to <System Q> (page 42).
- Pressing **A** button, **B** button, or any button other than **C** will immediately return to normal display.

## Watching DVD/VCD (video CD)/Video (MPEG) files

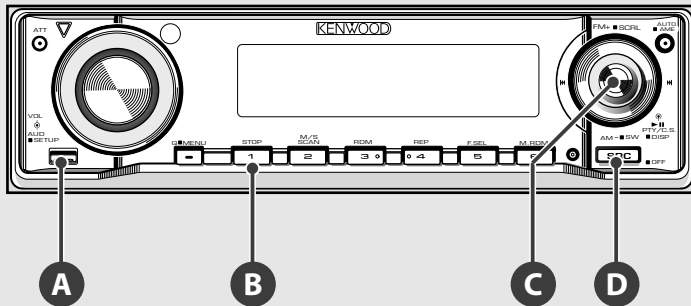

### A I

#### Playing a DVD/VCD/Video file

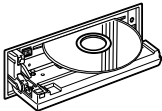

Press button **A** to open the operation panel.

When you load a disc into the disc loading slot, the disc starts playing.

If a menu appears, move the cursor on a feature using the cursor key **I**, and select it by pressing the ENTER key **I**.

#### Remove a disc

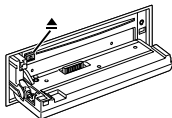

Press (Eject) button.



- Insert the disc horizontally.
- When a disc is inserted, the indicator lamp turns on.
- When a disc is already loaded in this unit, you can play it by switching to "DVD" with the button **D**.
- In addition to the DVD videos available on the market, you can view video (MPEG) files recorded on DVDs. For further information on the types of video files that can be played, disc formats etc, refer to <Video files> (page 64).
- For other playback methods, refer to <Watching DVD/VCD/Video files> (page 20).
- The position of the remote controller switch must be changed according to the source used. For further information, refer to <Remote Controller mode switch> (page 58).

### F K

#### Select a chapter/scene/track

Pressing key **F** to play back the previous chapter/scene/track.

Pressing key **K** to play the next chapter/scene/track.

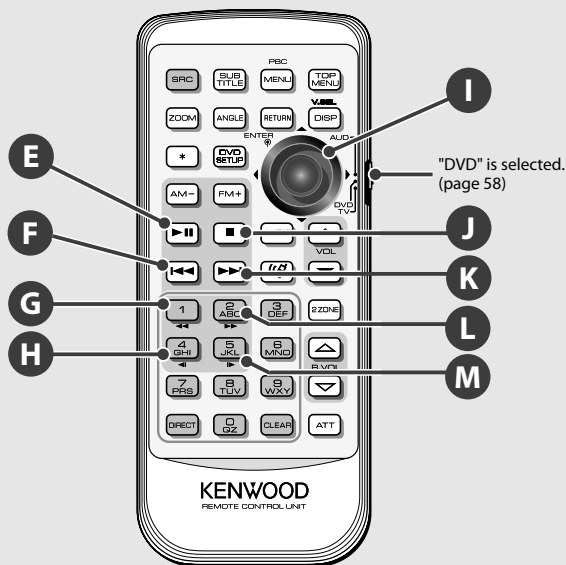

- The same operation is possible by sliding control knob **C** to the left or right.

**E J****Stop play**

Press **■** key **J** to stop playing.  
 Press **⏮** key **E** to resume playing from the position where play was previously interrupted.



- Press **■** key **J** twice to start playback of a DVD from the beginning when it is played next.
- Pressing **⏮** button **E** can also stop playing.
- Pressing control knob **I** can also resume playing.

**E****Play/Pause**

Press **⏮** key **E** once to pause.  
 Press again to resume playing.



- The same operation is possible by pressing control knob **I**.

**G L****Fast scan forward/backward**

Press **⏮** key **G** for fast backward scanning.  
 Press **⏭** key **L** for fast forward scanning.  
 Each time **⏮** key **G**/ **⏭** key **L** is pressed, the forward/backward scan speed changes in 3 steps.

**H M****Slow play**

Press **⏭** key **M** for slow forward play.  
 During DVD playback, press **⏮** key **H** for slow backward play.  
 Each time **⏭** key **M**/ **⏮** key **H** is pressed, the slow play speed changes in 3 steps.



- During driving, the image from the DVD/VCD/video files will not be displayed for safety reasons. The image is displayed after the vehicle stops and the parking brake is applied.
- When on-screen display is shown on the monitor, use the cursor key **I** operating menus. If you want to perform other operations, turn off the on-screen display.

## Listening to CDs and audio files

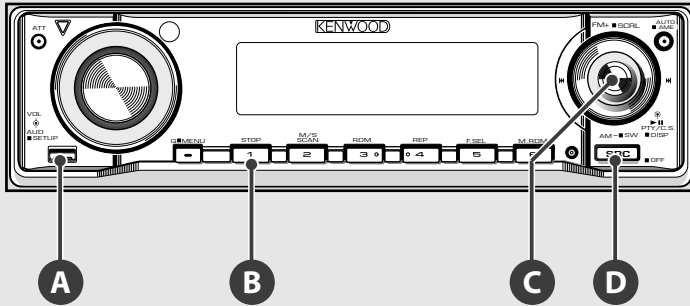

**A**

### Playing CD/audio files

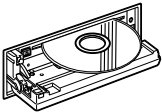

Press  button **A** to open the operation panel.

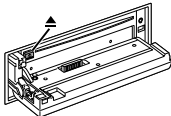

When you load a disc into the disc loading slot, it starts playing.

### Remove a disc



Press  (Eject) button. The disc is ejected.



- Insert the disc horizontally.
- When a disc is inserted, the  indicator lamp turns on.
- If a disc is already loaded in this unit, you can play it by switching to "DVD" with the  button **D**.
- Apart from normal CDs, you can also play CD-Rs (etc.) with audio files.  
For further information on the types, formats, and writing methods of playable audio files, refer to <Audio files> (page 62).
- For further information on playing methods, refer to <Listening to Music Discs & Audio Files> (page 30).



**C****Fast scan forward/backward**

Push control knob **C** to the right and hold it for fast scanning forward through the track.

Push control knob **C** to the left and hold it for fast scanning backward through the track.

**C****Select a track to play**

Move control knob **C** to the right to play the next track.

Move control knob **C** to the left to return to the start of the current track or play the previous track.

**B C****Stop play**

Press  button **B** to stop playing.

Press control knob **C** to resume playing from the previous interrupted position.



- Press  button **B** twice to start the disc from the beginning when it is played next.

**C****Play/Pause**

Press control knob **C** once to pause.

Press again to resume playing.

## Viewing picture (JPEG) files

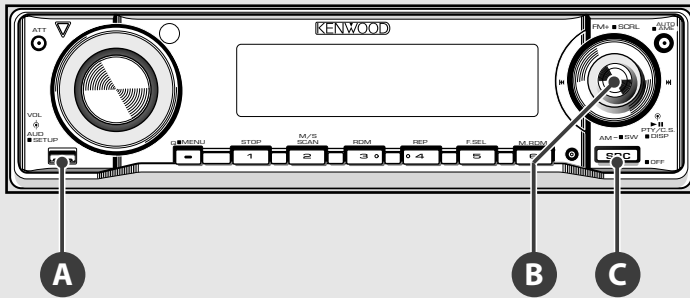

**A**

### Display picture files

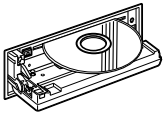

Press button **A** to open the operation panel.

Insert a disc containing picture files into the loading slot to display the files.

The picture file is displayed for 20 seconds before moving to another picture file.

### Remove a disc

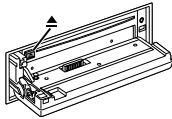

Press [] (Eject) button.



- The length of time the picture file is displayed can be changed. For details on how to set the time, refer to <Monitor display setup> (page 24).
- Insert the disc horizontally.
- When a disc is inserted, the indicator lamp turns on.
- When a disc is already loaded in this unit, you can play it by switching to "DVD" with the button **C**.
- For further information on the types of displayable picture files, disc formats etc., refer to <Picture files> (page 64).

**B**

### Select a picture file to display

Move control knob **B** to the left to display the previous picture file.

Move control knob **B** to the right to display the next picture file.

**B**

### Pausing display

Pressing control knob **B** once freezes the display. When it is pressed again, the picture file starts changing again, the picture file starts changing again.



- During driving, the image from the picture files will not be displayed for safety. The image is displayed after the vehicle stops and the parking brake is applied.

## Listening to radio

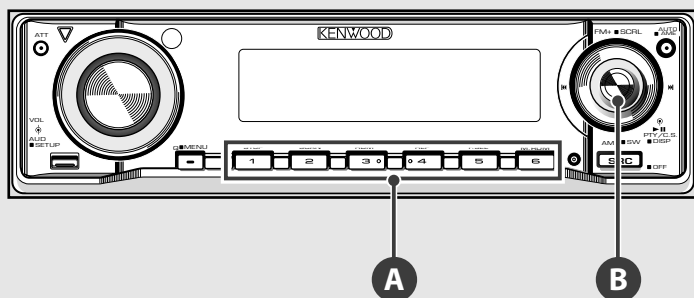

### B Changing the radio band

Move control knob **B** up to change the radio bands as follows:

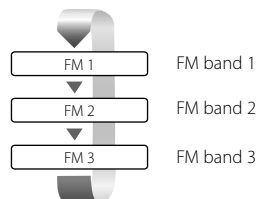

- The **[ST]** indicator turns on during stereo reception.
- For various other tuning methods, refer to <Listening to Radio> (page 36).

Move control knob **B** downwards to change the radio band to AM.

### B Selecting a radio station

Move control knob **B** left or right to automatically search for the best reception of a radio station.



- Depending on the tuning mode, you can change the frequency step by step, or receive each memorized radio station sequentially. For further information, refer to <Tuning mode> (page 37).

### A Receive a preset radio station

Press a button to select the station memorized.



- To use the preset tuning function with **A**, you need to preset a radio station for each button in advance. For detail on how to memorize stations, refer to <Auto memory> (page 36) or <Manual memory> (page 36).

# Watching DVD/VCD/Video files

You can play DVD/VCD/Video files using various functions.



- For the basic method of how to watch DVD/VCD/Video files, refer to <Watching DVD/VCD (video CD)/Video (MPEG) files> (page 14).
- Set the remote controller mode switch to "DVD" mode before starting operation, refer to <Remote Controller mode switch> (page 58).

## Frame-by-frame playback

Plays back by moving frame by frame.

### 1 Pause playback



### 2 Play back frame by frame

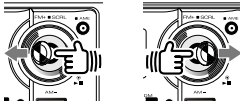

Move control knob to the right to move forward frame by frame.  
Move control knob to the left to move backward frame by frame.



- When playing back a video file, playing frame-by-frame backward is disabled.

## Repeat play

Repeats the chapter or track being played.

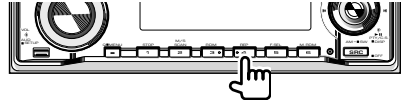

### While playing DVDs

Display	Status
"TITL REP"	Title repeat ON
"CHAP REP"	Chapter repeat ON
"REP OFF"	Repeat play OFF

### While playing VCDs

Display	Status
"TRAC REP"	Track repeat ON
"REP OFF"	Repeat play OFF

### While playing video files

Display	Status
"FILE REP"	File repeat ON
"FOLD REP"	Folder repeat ON
"REP OFF"	Repeat play OFF



- The VCD repeat play function is enabled when the PBC is set to OFF.  
For further information on PBC setting, refer to <PBC setup> (page 23).

## Changing audio channel (Only for VCD)



Sets up the audio channel.



The setting changes as follows each time the key is pressed.

Display	Setting
"LL"	Only left audio channel is output.
"RR"	Only right audio channel is output.
"ST"	Stereo sound is output.



- The audio channel can also be changed by pressing  on the main unit.

## Changing sound track language (Only for DVD)



Changes the sound track language.



The language changes each time the button is pressed.



- On some discs you cannot change the language using this button. In this case, change it from the DVD menu or the DVD setup.

## Changing subtitle language (Only for DVD)



Changes the subtitle language.



The language changes each time the key is pressed.



- On some discs you cannot change the subtitle language using this button. In this case, change it from the DVD menu or the DVD setup.

## Changing viewing angle (Only for DVD)



Selects a viewing angle.

When the angle mark  ...



The angle changes each time the key is pressed.



- On some discs you cannot change the angle using this button. In this case, change it from the DVD menu or the DVD setup.



## Zoom

Enlarges and displays the screen image.

### 1 Set the zoom ratio



The magnification ratio changes in 3 steps each time the key is pressed.

### 2 Select a display position



The display position moves in the direction of the arrow pressed.



- Zooming may not be possible with some discs, or zoom may be canceled in some scenes.



## DVD menu (Only for DVD)

Sets the DVD menu.

### 1 Display a DVD menu



### 2 Select a feature



The cursor moves in the direction of the arrow pressed. Move the cursor to the desired feature. For the DVD menu, also refer to the DVD operation manual.

### 3 Determine the feature



To cancel the menu ...



To return to the first menu feature ...

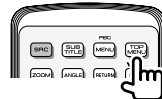

- Switching to the first menu feature with **FIRST MENU** may not be possible with some discs.



## PBC setup (Only for VCD)

Sets up PBC (Play Back Control).



Each time the key is pressed, the PBC function turns ON/OFF.

# DVD setup

Sets up display (etc.)-related functions.



- For the basic method of how to watch DVD/VCD/Video files, refer to <Watching DVD/VCD (video CD)/Video (MPEG) files> (page 14).
- Set the remote controller mode switch to "DVD" mode before starting operation, refer to <Remote Controller mode switch> (page 58).
- Perform this setting without a disc being loaded in this unit.

## Monitor display setup



Specifies the information etc to be displayed on the monitor.

### 1 Set to Setup mode



### 2 Open the display menu

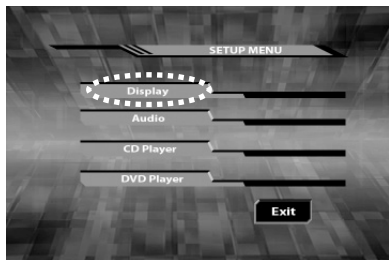

### 3 Select features to set

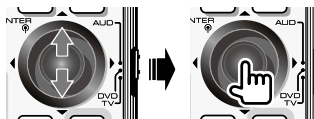

Select additional features for JPEG setup.



## 4 Set up the features

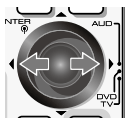

### Status Information

Turns the status and icon display ON/OFF.

Display	Setting
"ON"*	Displayed
"OFF"	Not displayed

### Background

Selects one of 2 types of wallpapers.

Display	Setting
"Type1"*	Type 1
"Type2"	Type 2

### Audio Information

Turns text information display ON/OFF.

Display	Setting
"ON"*	Displayed
"OFF"	Not displayed

### JPEG SETUP MENU

#### Display Time

Specifies the length of time for which JPEG images are displayed.

Display	Setting
"Short"	Displayed for 10 seconds
"Middle"*	Displayed for 20 seconds
"Long"	Displayed for 30 seconds



## Display Effect

Turns visual effects ON/OFF.

Display	Setting
"ON"*	Visual effects are added.
"OFF"	Visual effects are not added.

\* Indicates default configuration status after purchase.

### 5 Exit the setup

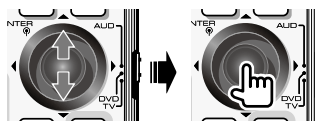
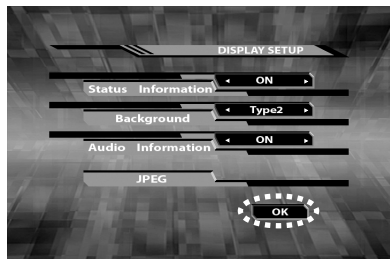

After **OK** is selected on each screen the previous screen appears.

## Audio setup

Sets up the DVD audio functions.

### 1 Set to Setup mode



### 2 Open the audio menu

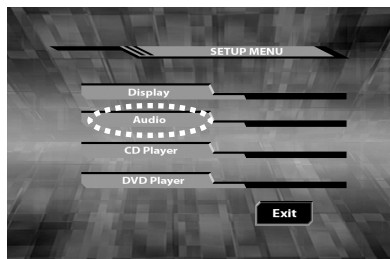

### 3 Set up the features

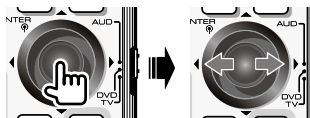

## Dynamic Range

Specifies the audio dynamic range when a title supporting Dolby digital is playing.

Display	Setting
"Wide"*	Sets to wide range
"Normal"	:
"Midnight"	Sets to narrow range

\* Indicates default configuration status after purchase.

### 4 Exit the setup

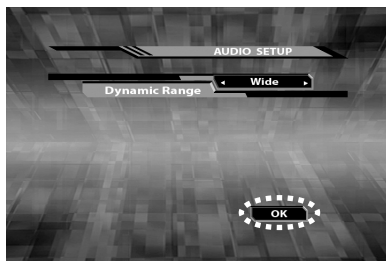

After **OK** is selected on each screen the previous screen appears.



### CD player setup

Sets up the CD player for playback.

#### 1 Set to Setup mode



#### 2 Display the CD player menu

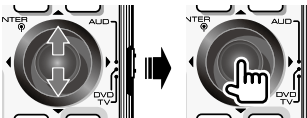
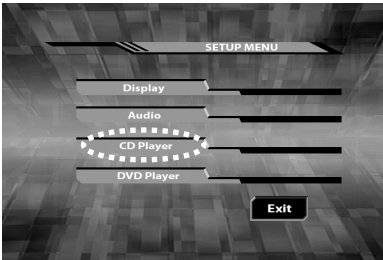

#### 3 Set up the features

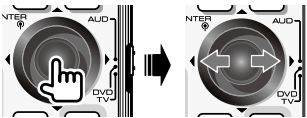

#### CD Read

Specifies the method for reading a CD.

Display	Setting
1*	Audio file discs and music CDs are identified automatically.
2	It overrides to play the disc as a CD.

\* Indicates default configuration status after purchase.

#### 4 Exit the setup

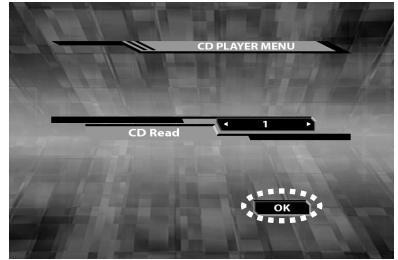

After **OK** is selected on each screen the previous screen appears.



### DVD player setup

Sets up the languages, display, etc. for DVD playback.

#### 1 Set to Setup mode



#### 2 Open the DVD player menu

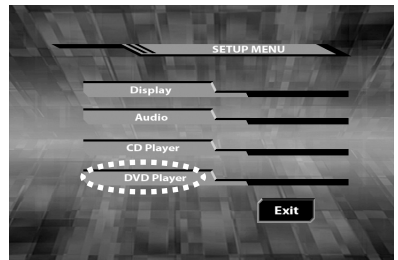

**3 Select features to set**

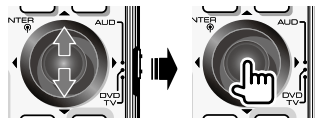

Select additional features for language setup.



**4 Set up the features**

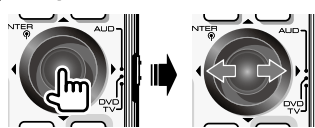

**Language**

Sets up the subtitles displayed, audio, etc. for DVD playback.  
For further information on the setting method, refer to <Language setup> (page 28).

**Parental**

Sets up a parental level.  
For the setup method, refer to <Parental level setup/change> (page 29).

**TV Type**

Sets the picture aspect ratio 16:9 according to the TV type.

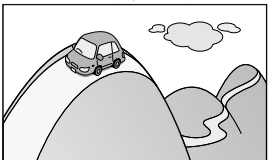
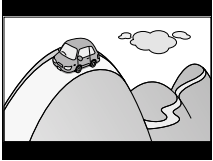
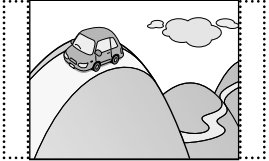
Display	Setting
16:9	A 16:9 monitor displays a 16:9 picture. 
Letter Box	A 4:3 monitor displays the picture in letter box style (A black band appears at the top and bottom of the screen). 
Pan Scan	A 4:3 monitor displays the picture in Pan Scan style (The left and right edges of the picture will be cut off). 

**5 Exit the setup**

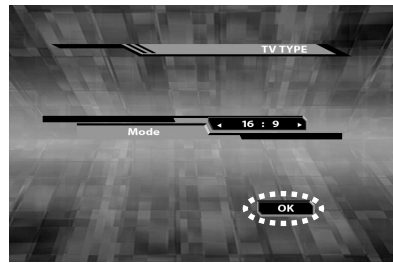

After **OK** is selected on each screen the previous screen appears.



## Language setup

Sets up the DVD subtitle and audio menu languages.

### 1 Display the language menu screen

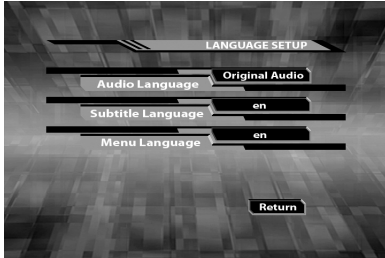

Refer to <DVD player setup> (page 26).

### 2 Select language features to set



Display	Setting
"Audio Language"	Sets the audio language.
"Subtitle Language"	Sets the subtitle language.
"Menu Language"	Sets the menu language.

### 3 Enter a language code

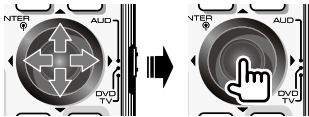

For the language code, refer to <DVD language codes> (page 72).

Display	Setting
"Original"	Sets the DVD's original language (only when setting an audio language).
"Return"	Cancel the setup and returns to the previous screen.
"Clear"	Clears the code entered.

### 4 Exit the setup

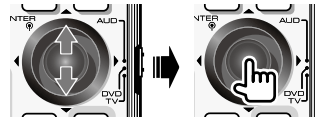
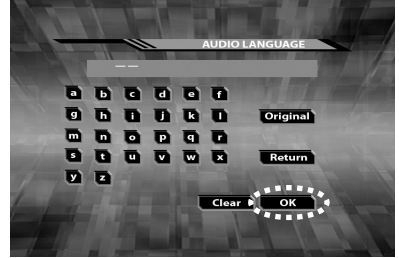

After **OK** and **Return** are selected on each screen the previous screen appears.

## Parental level setup/change



Changes the parental level and password for discs and scenes.

### 1 Display the Parental screen

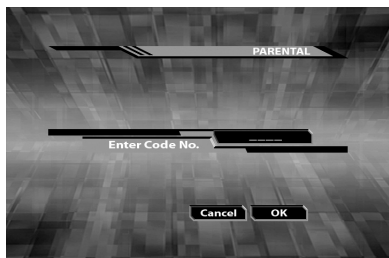

Refer to <DVD player setup> (page 26).  
When setting it for the second time and after, the message "Input Code No." will be displayed.

### 2 Enter a 4-digit password, and select OK



### 3 Select features to set

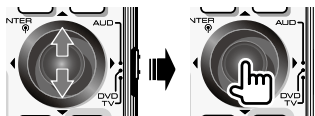

#### Level

Set the parental level.

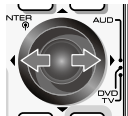

Display	Setting
"OFF"	Parental level is not set.
"1"	Parental level High
⋮	⋮
"8"	Parental level Low

#### Code No.

This needs to be entered when changing the password for the parental level.

Enter a 4-digit password, and select **OK**.



### 4 Exit the setup

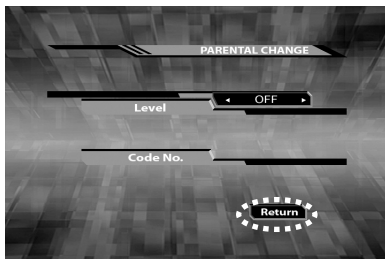

After **OK** and **Return** are selected on each screen the previous screen appears.



- Resetting this unit will clear the parental level and password.
- Some discs may require you to enter a password before a scene appears that has a parental level higher than specified. In this case, the playback resumes when you enter the password.
- If the disc being played has no parental level, playback is not restricted.

# Listening to Music Discs & Audio Files

You can play CDs and audio files using various functions of this unit and the optional disc changer.



- For the basic operation of how to listen to CDs and audio files, refer to <Listening to CDs and audio files> (page 16).

## Disc/Folder search

(Only for audio files and disc changers)

Selects a disc or folder to play.

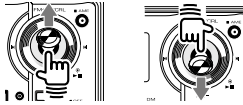

- The disc search is enabled when the disc changer (optional accessory) is used.
- For further information on folder search, refer to <Audio files> (page 62).

## Repeat play

Repeatedly plays back the track being played or the tracks/music files in a disc/folder.

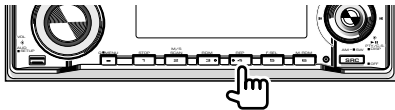

Pressing the button turns the following functions ON/OFF in the following order.

### While playing CDs

Display	Status
"TRAC REP"	Track repeat ON
"DISC REP"*	Disc repeat ON
"REP OFF"	Repeat play OFF

\* Only for disc changer

### While playing audio files

Display	Status
"FILE REP"	File repeat ON
"FOLD REP"	Folder repeat ON
"REP OFF"	Repeat play OFF

## Scan play

Searches for a track/file by scanning the first 10 seconds of each track/file in a disc/folder.

### 1 Start scan play

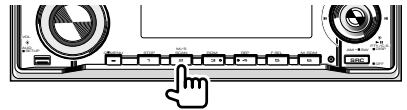

- ▶ TRAC SCN (while playing a CD)
- ▶ FILE SCN (while playing an audio file)

### 2 When you get to a track/file you want to hear ...

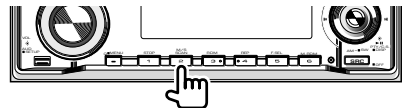

Scanning ends and playback of the track/file starts.



- After all tracks/files are scanned and played, the scan play ends automatically.



: Press for # seconds.

## Random play

Performs random playback of the tracks/files in a CD/folder.

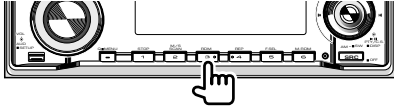

▶ **DISC RDM** (while playing a CD)

▶ **FOLD RDM** (while playing an audio file)

Each time the button is pressed, the random play mode is alternately turned ON/OFF.



- Move control knob to the right to randomly select the next track/file.

## Title/Text scroll

Scrolls titles/text.



- The following title/text can be scrolled.
  - Disc titles/Track titles
  - Song titles/Album titles/Folder names/File names
- Titles/text displayed on the monitor will not scroll with this operation.
- If "DISP" is set to "OFF" in the <Menu setup> (page 48), the display may be turned off during scrolling.

## Magazine random play

(Only for disc changer)

Randomly plays the tracks in the discs inside the disc changer.



▶ **MGZN RDM**

Each time the button is pressed, the magazine random play mode is alternately turned ON/OFF.



- Move control knob to the right to randomly select the next track/file.

# Select Mode

You can select a desired audio file or video file/picture by specifying a file number or folder name. Unlike the disc search and folder search, the file to be played will not change until the file/the folder is confirmed.



- In select mode, audio files, video files, and picture files can only be operated during playback.

## Select mode

### 1 Set to Select mode

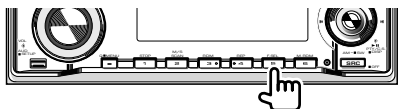

### 2 Select the Select mode

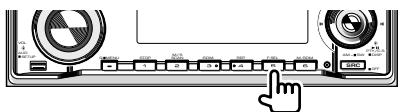

The select mode changes in the following order each time the button is pressed.

Display	Setting
"FILE SEL"	File select mode
"FLD SEL1"	Folder select 1 mode
"FLD SEL2"	Folder select 2 mode
Normally	Select mode OFF

### 3 Select a file or folder

For detailed operation methods, refer to <File select> (page 32), <Folder select 1> (page 33), and <Folder select 2> (page 33).



- During <Scan play> (page 30) or <Random play> (page 31), you cannot select the file select mode.
- For details on how to use the select mode, refer to <Audio files> (page 62).
- Titles can be scrolled even in the select mode. For further information, refer to <Title/Text scroll> (page 31).

## File select

Selects a file from a folder being played according to a specified file number.

### 1 Set to the file select mode

The name of the first file in the folder is displayed.  
For details on how to select the mode, refer to <Select mode> (page 32).

### 2 Enter a file number

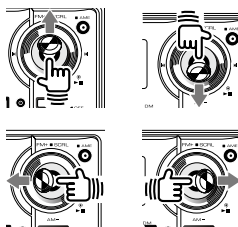

Control knob operation	Increment/decrement file number
Up	+10
Down	-10
Right	+1
Left	-1

The name of the file whose file number you entered is displayed.

### 3 Play the file displayed





## Folder select 1

Searches for a folder in the order of the media directory. This method is useful if audio files are sorted in folders by category and artist.

### 1 Set to the folder select 1 mode

For details on how to select the mode, refer to <Select mode> (page 32).

### 2 Select a folder

To select a folder in the same directory ...

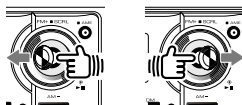

Each time you move the knob to the left moves you to the previous folders and moving the knob to the right moves you can move to the following folders.

To move to another directory ...

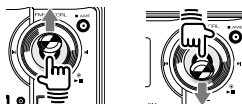

Each time you move the knob up moves you to the next lower folder level and moving the knob down moving to the next higher folder level.

To move back to the 1st level ...

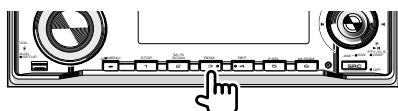

### 3 Plays the folder displayed

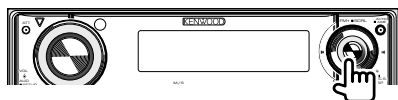

## Folder select 2

Selects folders in their order. Only folders containing playable audio files are displayed.

### 1 Set to the folder select 2 mode

For details on how to select the mode, refer to <Select mode> (page 32).

### 2 Select a folder

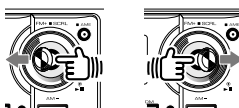

Each time you move the knob to the left moves you to the previous folders and moving the knob to the right moves you can move to the following folders.

To display the name of files contained in the folder shown ...

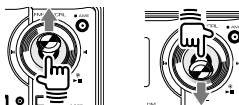

Each time the knob is moved up, the next higher level folder names are displayed. While higher level folders are displayed, "\*" appears. If the knob is moved down, the next lower-level folder names are displayed.

### 3 Play the folders displayed



- Even when the next higher level folder name is displayed, the folder playing is the folder currently selected (not marked "\*"). The folder currently selected will not change.

# Watching picture files

You can display picture files using various functions.



- For the basic method of how to view picture files, refer to <Viewing picture (JPEG) files> (page 18).

## Repeat play

Repeatedly displays the picture file being watched or the files in a folder.

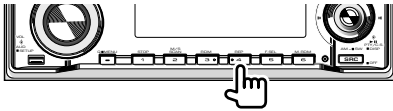

Pressing the button turns the following functions ON/OFF in the order given below.

Display	Status
"FILE REP"	File repeat ON
"FOLD REP"	Folder repeat ON
"REP OFF"	Repeat play OFF

## Scan play

Displays and scans pictures in a folder for 10 seconds one at a time.

### 1 Start scan play

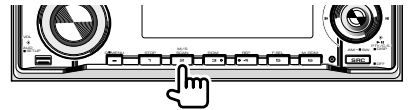

▶ FILE SCN

### 2 From a desired file ...

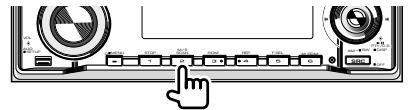

The scan play ends and playback starts from the file.



- After all files are scanned and played, the scan play ends automatically.



## Random play

Performs random display of the picture files in the displayed folder.

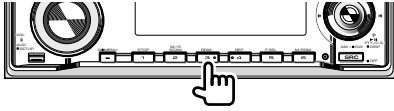

### FOLD RDM

The random play mode is turned ON/OFF alternately each time the button is pressed.



- Move control knob to the right to randomly select the next file.

## Stop display

Stop displaying picture files.



### Resume display



Resumes display from the position where display was stopped.



- Press the key twice to display the pictures from the beginning of the disc.
- Press the button of the unit can also stop display. Press control knob to resume display.

## Rotate/flip a picture

Rotates or flips a picture.

### Rotate to the right



Each time the button is pressed, the picture rotates 90 degrees clockwise.

### Rotate to the left



Each time the button is pressed, the picture rotates 90 degrees counterclockwise.

### Flip horizontally



Press again to restore to the previous picture.

### Flip vertically



Press again to restore to the previous picture.

# Listening to Radio

Receives FM/AM broadcasts. You can memorize up to 6 stations in each radio band.



- For the basic method of how to listen to FM/AM broadcasts, refer to <Listening to radio> (page 19).

## Auto memory

Scans to automatically memorize stations with the best reception.

### 1 Select a radio band

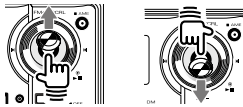

### 2 Start auto memory



▶ A-MEMORY



- The auto memory ends after 6 stations have been memorized or the whole frequency has been scanned.

## Manual memory

Memorizes the stations received.

### 1 Select a radio band



### 2 Select a radio station

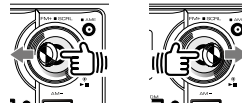

### 3 Select a button (1-6) to preset

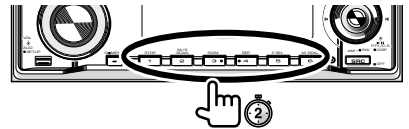

▶ FM1-92.1 3ch



- This function is useful to memorize a station that cannot be memorized with the auto memory function.

## Tuning mode

Sets a tuning mode for selecting stations.

### 1 Select a tuning mode



The mode changes in the following order each time the button is pressed.

Display	Setting
"AUTO 1"	Receives stations with the best reception. (Auto 1)
"AUTO 2"	Receives the stations memorized. (Auto 2)
"MANUAL"	Switches the receiving frequencies up and down a step at a time. (Manual)

# RDS Control

Controls the reception RDS broadcast station programs.

## PTY (Program Type)

Selects the Program Type and searches for a station.

### 1 Enter PTY mode



### 2 Select the Program Type

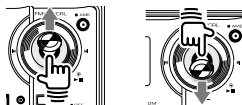

Each time the button is pressed, the type changes in the following order.

No	Program Type	Display
1.	Speech	"SPEECH"
2.	Music	"MUSIC"
3.	News	"NEWS"
4.	Information	"INFORM"
5.	Sports	"SPORTS"
6.	Talk	"TALK"
7.	Rock	"ROCK"
8.	Classic Rock	"CLS ROCK"
9.	Adult Hits	"ADLT HIT"
10.	Soft Rock	"SOFT RCK"
11.	Top 40	"TOP 40"
12.	Country	"COUNTRY"
13.	Oldies	"OLDIES"
14.	Soft	"SOFT"
15.	Nostalgia	"NOSTALGA"
16.	Jazz	"JAZZ"
17.	Classical	"CLASSICL"
18.	R & B	"R & B"
19.	Soft R & B	"SOFT R&B"
20.	Language	"LANGUAGE"

No	Program Type	Display
21.	Religious Music	"REL MUSC"
22.	Religious Talk	"REL TALK"
23.	Personality	"PERSONLTY"
24.	Public	"PUBLIC"
25.	College	"COLLEGE"
26.	Weather	"WEATHER"

### 3 Search for a station with the selected Program Type

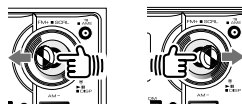

When you want to search for other stations

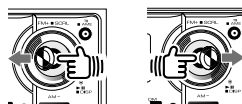

### 4 Exit PTY mode



- The PTY function cannot be used during a traffic bulletin or AM reception.
- Speech and Music include the Program type below.  
Music: No.7 — 19, 21  
Speech: No.3 — 6, 20, 22 — 26
- The Program Type can be stored in the [1] — [6] button memory and recalled quickly. Refer to the <Program Type Preset> (page 39).
- When the selected Program Type is not found, "NO PTY" is displayed. Select another Program Type.

## Registration of a station as a PTY

Registers a Program Type for stations without PTY data.

### 1 Receive the station you want to register

### 2 Select the Program Type to register

Refer to <PTY (Program Type)> (page 38).

### 3 Register the Program Type



### Confirming the Program Type



The Program Type is displayed for 5 seconds.

### 4 Exit PTY mode

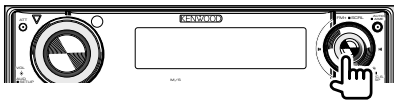

## Program Type Preset

Putting the Program Type in the Preset button memory and quick recall.

### Presetting the Program Type

#### 1 Select the Program Type to preset

Refer to <PTY (Program Type)> (page 38).

#### 2 Preset the Program Type

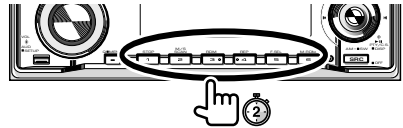

### Recalling a preset Program Type

#### 1 Enter PTY mode

Refer to <PTY (Program Type)> (page 38).

#### 2 Recall the Program Type

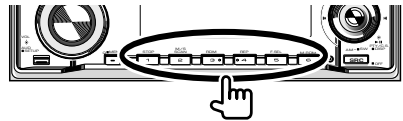

## Radio Text Scroll

Scrolling the displayed radio text.



- If "DISP" is set to "OFF" in the <Menu setup> (page 48), the display may be turned off during scrolling.

# Audio Control

Sets up sound effects, such as equalizer and speaker settings.

## Detailed audio control

The following features can be set up under audio control.

Display	Setting
"R-VOL"	Adjusts the volume of the rear speakers. (Adjustable range: 0 – 35)
"SW L"	Adjusts the volume of the subwoofers. (Adjustable range: -15 – +15)
"BAS L"	Adjusts the bass volume.
"MID L"	Adjusts the middle volume.
"TRE L"	Adjusts the treble volume.
"BAL"	Adjusts the volume balance between the left and the right.
"FAD"	Adjusts the volume balance between the front and the rear.



- For the setup method, refer to <Adjusts sound quality and others> (page 13).
- Bass, Middle, and Treble can be set up for each source.
- "R-VOL" can be adjusted when the dual zone function is set to ON.  
"SW L" and "FAD" cannot be adjusted if the dual zone function is set to ON.  
For further information on the dual zone function, refer to <Audio setup> (page 40).
- "SW L" can be adjusted if "SWPRE" is set to "SW" in the menu setup while the subwoofer output is set to ON.  
For details on how to set up "SWPRE", refer to <Menu setup> (page 48), and for subwoofer output, refer to <Subwoofer output control> (page 42).
- "SW L" cannot be adjusted if "SWPRE" is set to "AV".

## Audio setup

Sets up volume offset, dual zone function, etc.

### 1 Start audio setup

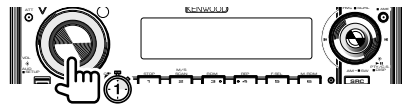

### 2 Select features to set

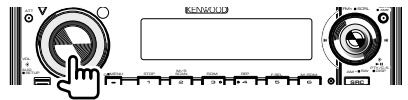

Each time the knob is pressed, the type changes in the following order.

Feature	Setting range
HPF	Specifies the front high-pass filter cutoff frequency.
HPR	Specifies the rear high-pass filter cutoff frequency.
LPF	Specifies the low-pass filter cutoff frequency.
PHAS	Specifies the subwoofer phase.
V-OFF	Adjusts the volume difference between sources.
LOUD	Corrects treble and bass when the volume is low.
AVOUT	Specifies the output level of the AV OUT terminal.
ZZON	Turns the dual zone function ON/OFF.



### 3 Set up each feature

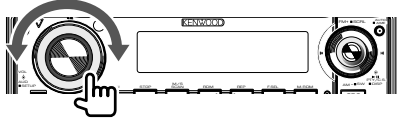

The setting range of each item is as follows:

Feature	Setting range
HPF/HPR	THRU (Filter Off)/40/60/80/100/120/150/180/220 (Hz)
LPF	50/60/80/100/120 (Hz)/THRU (Filter Off)
PHAS	REV (180°)/NML (0°)
V-OFF	-8 - 0
LOUD	OFF/ON
AVOUT	-15 - 0
ZZON	OFF/DVD/AUX

### 4 Exit audio setup

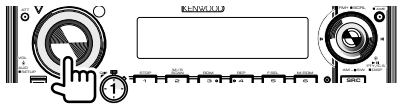

- If a volume offset is set for each source with "V-OFF", the volume will be nearly the same for all sources when the source is changed.
- You can select "AUX" for "2ZON" when CA-C1AX/CA-C2AX (optional accessory) is connected.
- When "2ZON" is ON ("DVD"/"AUX"), you can only set "V-OFF" and "LOUD".
- When using the dual zone function, different sources can be output from the front speakers (source of this unit) and rear speakers (disc source sound of this unit).
- For "LPF" and "PHAS", the feature "SWPRE" needs to be set to "SW" (subwoofer) in advance in the menu setup, and the subwoofer output to ON. For details on how to set up "SWPRE", refer to <Menu setup> (page 48), and for subwoofer output, refer to <Subwoofer output control> (page 42).
- "PHAS" cannot be set up when "LPF" is set to "THRU".
- "AVOUT" can be set when the feature "SWPRE" in <Menu setup> (page 48) is set to "AV".

### Speaker setup

Fine adjust the System Q value to the speakers.

#### 1 Set to STANDBY mode



Select "STANDBY".

#### 2 Set to the speaker matching mode

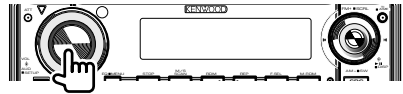

#### 3 Select a speaker

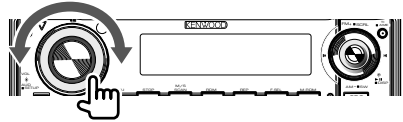

Each time the knob is rotated, the indication changes in the following order.

Display	Speaker type
"SP OFF"	OFF
"SP 5/4"	For 5 & 4 in. speakers
"SP 6*9/6"	For 6 & 6x9 in. speakers
"SP OEM"	For OEM speakers

#### 4 Exit the speaker matching mode

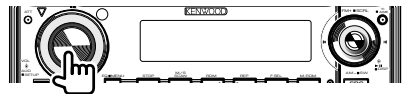

### System Q

Shows the equalizer curve for the song being played.

**1 Select the desired source**

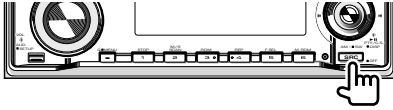

**2 Recall the System Q**

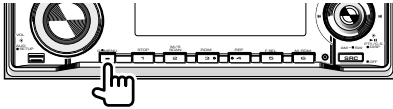

Each time the button is pressed, the type changes in the following order.

Display	Setting
"USER"	User
"ROCK"	Rock
"POPS"	Pops
"EASY"	Easy
"TOP40"	Top 40
"JAZZ"	Jazz
"NATURAL"	Natural



- The System Q can be set for each source.
- The System Q value varies depending on the settings made in the <Speaker setup> (page 41). Perform the <Speaker setup> in advance.
- "USER" is the value that was set the <Adjusts sound quality and others> (page 13).
- If the System Q setting is changed, the values ("BAS L", "MID L", and "TRE L") set in the <Adjusts sound quality and others> are replaced with the System Q value.

### Subwoofer output control

Turns the subwoofer output ON/OFF.



- SW ON (Subwoofer ON)
- SW OFF (Subwoofer OFF)



- Cannot be set when the dual zone function is activated.
- The subwoofer can be turned ON/OFF when the feature "SWPRE" in <Menu setup> (page 48) is set to "SW" (subwoofer).

# TEL Mute Control

The audio system automatically mutes when a call comes in.

## TEL Mute

### When a call comes in

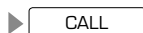

The audio system pauses.

### Listening to the audio during a call

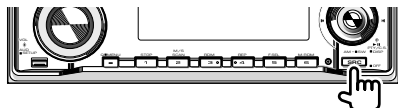

The "CALL" display disappears and the audio system comes back ON.

### When the call ends

Hang up the phone.

The "CALL" display disappears and the audio system sound comes back ON.



- To use the TEL Mute feature, you need to hook up the MUTE wire to your telephone using a commercial telephone accessory. Refer to <Connections> (page 74).

# Display Control

Set information to be shown on the display, select a file to play while watching the monitor, and detach/attach the panel.

## Selecting display information

Changes the information to be shown on the display.

### 1 Start display selection

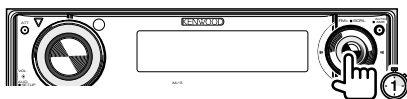

▶ DISP SEL

### 2 Select display information

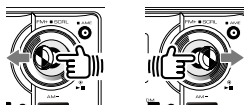

Each time the button is pressed, the type changes in the following order.

#### In STANDBY/AUX

Display	Setting
"SRC NAME"	"STANDBY"/AUX name
"CLOCK"	Clock

#### While receiving FM/AM and traffic information

Display	Setting
"FREQ/PS"	Program Service name or Frequency (FM)
"R-TEXT"	Radio text, Program Service name or Frequency (FM)
"FREQ"	Frequency indication (AM)
"CLOCK"	Clock

## While playing CDs

Display	Setting
"D-TITLE"*1	Disc title
"T-TITLE"*1	Track title
"P-TIME"	Track number & Play time
"A-TIME"*2	Disc play time
"R-TIME"*2	Remaining disc time
"CLOCK"	Clock

\*1 If not registered, play time is displayed instead.

\*2 Not displayed with CD changer.

## While playing audio files/video files/picture files

Display	Setting
"TITLE"*3*4	Song title & Artist name
"ALBUM"*3*4*5	Album title & Artist name
"FOLDER"	Folder name
"FILE"	File names
"P-TIME"	Track number & Play time
"V-LABEL"*4	Volume label
"CLOCK"	Clock

\*3 Video files or picture files cannot be displayed.

\*4 If not registered, play time is displayed instead.

\*5 The play time is displayed while playing WMA files.

## While playing DVDs

Display	Setting
"C-TIME"	Chapter play time
"T-TIME"	Title play time
"R-TIME"	Remaining disc time
"TNO:CNO"	Title/Chapter number
"V-LABEL"	Volume label
"CLOCK"	Clock



: Press for # seconds.

### While playing VCDs

Display	Setting description
"P-TIME"* <sup>6</sup>	Scene/Track play time
"S-TIME"* <sup>7</sup>	Scene play time
"A-TIME"* <sup>6</sup>	Disc play time
"R-TIME"* <sup>6</sup>	Remaining disc time
"V-LABEL"	Volume label
"CLOCK"	Clock

\*<sup>6</sup> Can be displayed when the PBC function is OFF.

\*<sup>7</sup> Can be displayed when the PBC function is ON.

### 3 Exit display selection

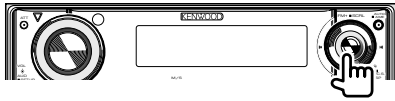

## Monitor information display & file selection



Displays information on the disc source being played, and selects a file to be played.

### 1 Display source information



Information on the source is displayed on the monitor.

This information remains displayed until an image is displayed on the monitor.

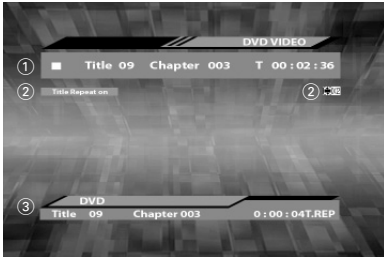

- ① **Media information**  
Play time and text information is displayed.
- ② **Status information**  
Play function setting status is displayed.
- ③ **Source information display**  
Receiving frequency, band, number of channels, etc. are displayed during radio reception.  
Play time, title/track/chapter number, setting status of each function, etc. are displayed while playing DVDs, etc.

### 2 Display disc and file information



Information on the disc and the file is displayed. Depending on discs, you can switch the displayed information as you press this button.

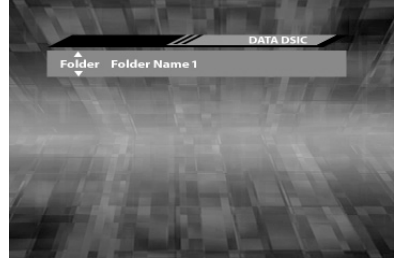

You can select the information to show when "▼" and "▲" are displayed.



### 3 Display the file list



Audio file, movie file, or picture file list is displayed.

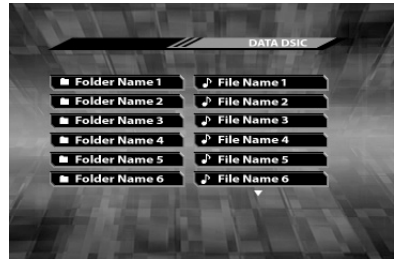

### 4 Select a file to play from the list



- The file list is not displayed if the disc being played does not have an audio file, movie file, or picture file.

## Removing operation panel

Removes the operation panel.

### 1 Open the operation panel

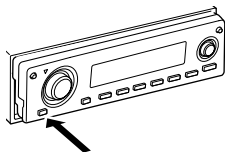

### 2 Remove the operation panel

Antitheft warning lamp

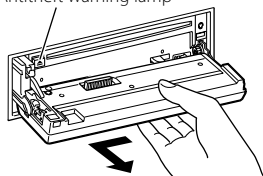

- Removing the panel turns off the power.
- Since the panel is a precision component, it may be damaged by shock when exposed to vibration or dropped. Store the panel with care after removing it.
- Do not store the removed panel in the following places.
  - Places exposed to direct sun light
  - Places with high humidity
  - Dusty places
- This unit is provided with a DSI (Security indicator) function. If the "DSI" feature is set to "ON" in the <Menu setup> (page 48), a warning lamp blinks when the panel is removed for antitheft purposes.

## Installing operation panel

Installs the operation panel.

### 1 Align the operation panel with the main unit

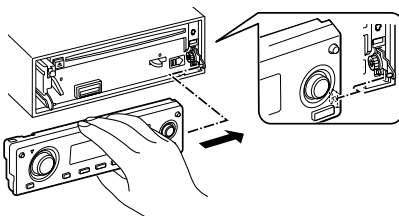

Push in the panel aligning the hole in the panel with the shaft at the right of the main unit.

### 2 Install the operation panel

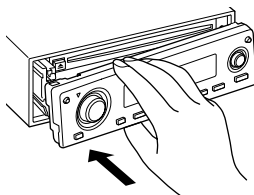

Push the left side of the panel into the main unit until it locks.  
The panel is now installed and the unit is ready for use.

# Menu

Setting up various functions.

## Menu setup

Sets up various functions for each source.

### 1 Select a source

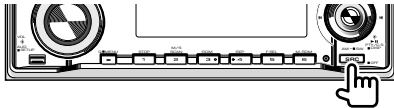

### 2 Set to the menu mode

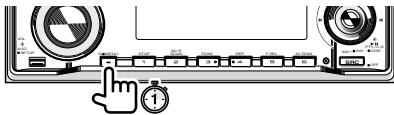

### 3 Select features to set

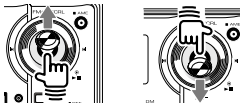

The features displayed vary depending on the source.

### 4 Set up each feature

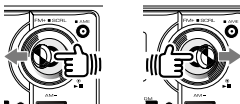

- For details on how to set features followed by a page number, refer to the page shown.

Display	Setting	Setting overview	Source
"CODE SET"/ "CODE CLR"	Refer to page 50	Sets/Resets security code	<b>SB</b>
"BEEP"	ON*/OFF	Sets beep tone ON/OFF.	<b>SB</b>
"CLK ADJ"	Refer to page 52	Sets the clock.	<b>SB</b>
"SYNC"	ON/OFF*	Specifies whether to synchronize the RDS station time data with the clock of this unit.	<b>SB</b>
"DSI"	ON*/OFF	Sets the antitheft warning LED.	<b>SB</b>
"KEY"	GRN/RED*	Sets the button illumination color.	<b>SB</b>
"DISP"	ON*/OFF	Turns off the display when not in use.	
"DIM"	ON*/OFF	Adjusts the brightness of the display according to the surrounding illumination.	<b>SB</b>
"SWPRE"	SW*/AV	Sets PREOUT output signal.	<b>SB</b>
"AMP"	ON*/OFF	Specifies whether the built-in amplifier is turned ON/OFF.	<b>SB</b>
"ZONE2"	R*/F	Sets the output destination of the dual zone function sub source.	<b>SB</b>
"TI"	ON/OFF* Refer to page 56	Specifies whether the traffic bulletin is switched to automatic start.	<b>SB</b>
"CRSC"	OFF/ON*	Switches to Monaural to decrease noise when reception is poor.	<b>FM</b>
"HDR MODE"	Refer to page 52	Sets the stations to be received with HD Radio.	<b>HDR</b>
"ESN"	No setting is available	Displays SIRIUS ID (Electronic serial number).	<b>SIRIUS</b>
"NAME SET"	Refer to page 53	Names the AUX source.	<b>AUX</b>
"SCL"	AUTO*/ MANU	Specifies whether the text is scrolled automatically.	
"CD READ"	1*/2	Sets the CD read mode.	<b>SB</b>
"A-PRESET"	Refer to page 54	Registers/recalls audio settings.	<b>SB</b>
"DEMO"	ON*/OFF Refer to page 54	Specifies whether to enable demonstration.	<b>SB</b>
"M/V"	No setting is available	Displays Macrovision version.	<b>DVD</b>

\* Indicates the default configuration after purchase.





: Press for # seconds.

- SB** : Can be set in standby state.
- SB** : Can be set in other than standby state.
- DVD** : Can be set while accessing DVD source.
- FM** : Can be set during FM reception.
- AUX** : Can be set while accessing AUX EXT source.
- HDR** : Can be set while accessing HD Radio source.  
(optional)
- SIRIUS** : Can be set while accessing SIRIUS source. (optional)

## 5 Exit menu mode

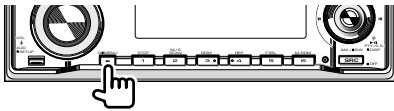

- "ZONE2" is displayed while the dual zone function is set to ON.
- "SWPRE" is displayed when dual zone function is turned OFF.
- "CD READ" can be set while no disc is inserted in the unit.
- "CLK ADJ" cannot be set if "SYNC" is set to "ON".
- For further information on each feature, refer to <Help? Term> (page 68).
- If a security code is set, "CODE CLR" (Reset) is displayed instead of "CODE SET" (Set).
- Changing "SWPRE" setting will change the "AVOUT" setting value of <Audio setup> (page 40) to "-15".
- "DISP" can be set when "DEMO" is "OFF".

## Setting security code

Sets a security code to prevent theft.



- To change/reset a security code, the security code is required. It is recommended that you write down your security code.
- Before setting a security code, turn off the demonstration mode. For further information, refer to <Demonstration setup> (page 54).

### 1 Set to the menu mode

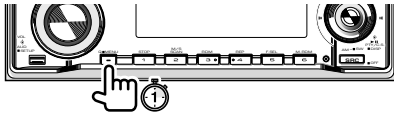

MENU

### 2 Select the security code set feature



### 3 Start security code setting

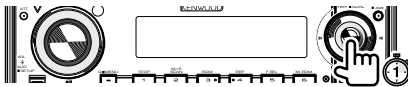

ENTER CODE : ----

### 4 Enter a security code

Select the digit to enter.

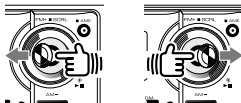

Select a number to enter.

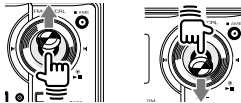

### 5 Confirm the entry

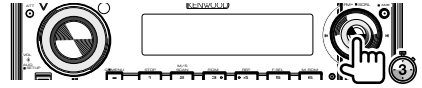

RE-ENTER CODE : ----

### 6 Repeat the entry

Using the same method as in the step 4, enter the same security code.

### 7 Confirm the entry

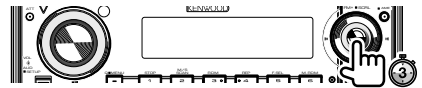

APPROVED

### 8 Exit the security code setting



- If the security code entered in step 6 is different from the code entered in step 4, you must repeat the procedure from step 4.
- Once the security code has been set, the code needs to be entered every time the Reset button is pressed or the battery is disconnected. For further information, refer to <Security code entry> (page 51).
- The security code can be set in the STANDBY state. For the basic method of how to operate the menu, refer to <Menu setup> (page 48).

## Clearing security code

Cancels the security code.

### 1 Set to the menu mode

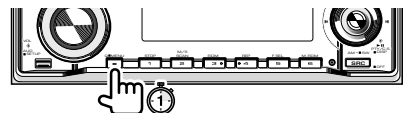

MENU



: Press for # seconds.

## 2 Display the security code canceling feature



## 3 Select the security code canceling feature

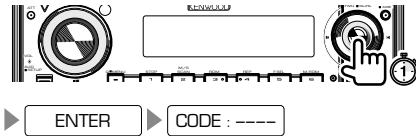

## 4 Enter a security code

Select the digit to enter.

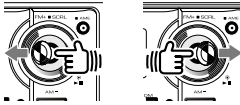

Select a number to enter.

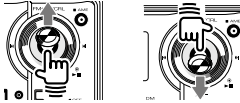

Enter the security code set in <Setting security code> (page 50).

## 5 Confirm the entry

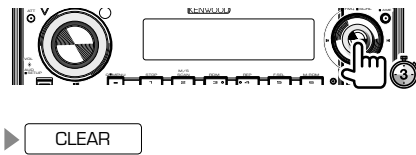

## 6 Exit the security code canceling

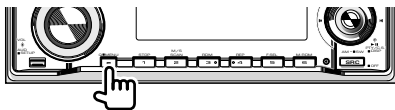

- The security code can be canceled in the STANDBY state. For the basic method of how to operate the menu, refer to <Menu setup> (page 48).
- If an incorrect security code is entered, "ERROR" is displayed. Repeat the procedure from step 4 to enter a correct code.

## Security code entry

If a security code is set, you must enter the code the first time you turn the unit on after the Reset button has been pressed or the unit has been disconnected to the battery of the car.

### 1 Enter a security code

Select the digit to enter.

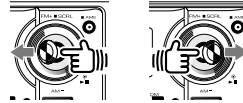

Select a number to enter.

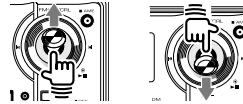

Enter the security code set in <Setting security code> (page 50).

### 2 Confirm the entry

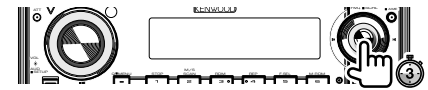

The power turns on.

▶ APPROVED



- If an incorrect security code is entered the power will turn off. In this case, press the **SRC** button to turn on the power and enter the security code again.

### Adjusting the clock

Adjust the clock of this unit.

**1 Set to the menu mode**

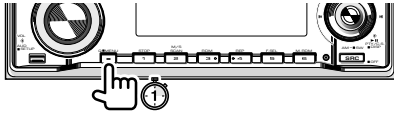

**2 Select the clock adjustment feature**



**3 Start clock adjustment**

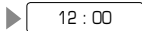

**4 Adjust "Hours"**

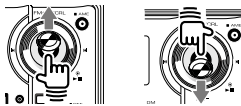

**5 Adjust "Minutes"**

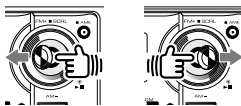

**6 Exit clock adjustment**

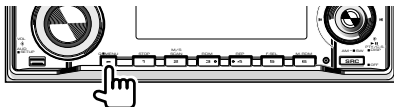

- After "Minutes" is adjusted, the clock starts with 00 seconds.

### HD Radio Receive mode setting

Setup for receiving HD Radio stations.

**1 Set to the menu mode**

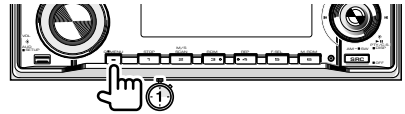

**2 Select the HD radio receive mode setting feature**



**3 Start Receive mode setting**

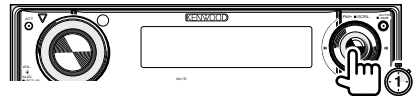

**4 Select Receive mode setting**



Display	Setting
"AUTO"	Analog broadcasts and digital broadcasts will be switched automatically. When both are being transmitted, the digital broadcast will have priority.
"DIGITAL"	Digital broadcasts only.
"ANALOG"	Analog broadcasts only.

**5 Exit Receive mode Setting.**

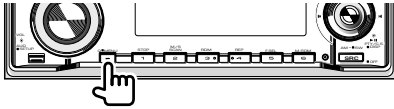

- Even if the Receive mode is set to "AUTO" while a Ball game mode program (non-delayed broadcast program) is received, the Receive mode will automatically switch to Analog broadcast only.

**AUX name select**

Specifies the display to appear when AUX source is selected.

**1 Select the AUX source**

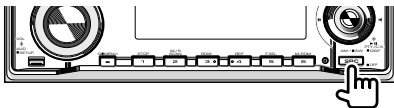

▶ AUX EXT

**2 Set to the menu mode**

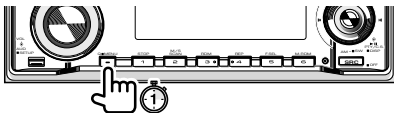

▶ MENU

**3 Select the name setting feature**



**4 Start name setting**



▶ AUX EXT

Press and hold down the knob until the name of the AUX EXT source being set is displayed.

**5 Select the AUX name**

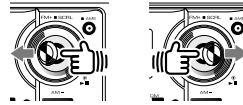

As you move the knob to the left or right, the AUX name changes in the following order.

Display
"AUX EXT"
"DVD"
"PORTABLE"
"GAME"
"VIDEO"
"TV"

**6 Exit the name set**

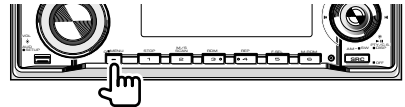

- If no operation is made for 10 seconds, the name displayed at that moment is selected.
- <AUX name select> can be set only for AUX input using KCA-S220A (optional accessory).

## Demonstration setup

Demonstrates the functions of this unit.

### 1 Set to the menu mode

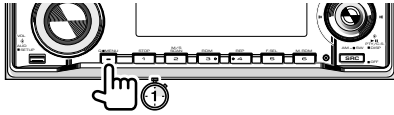

### 2 Select the demonstration feature



### 3 Set up the demonstration feature

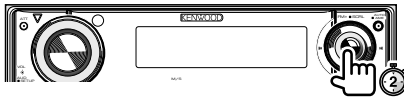

The demonstration function turns ON/OFF each time the button is pressed and held down for 2 seconds or more.



- This setting can be used in the standby state. For the basic method to operate the menu, refer to <Menu setup> (page 48).

## Audio preset

Memorizes the audio settings. These will be retained even when the Reset button is pressed.

### 1 Set up audio control settings to be memorized

Refer to <Detailed audio control> (page 40) and <Audio setup> (page 40).

### 2 Set to the menu mode

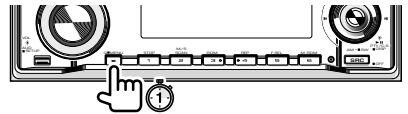

### 3 Select the Audio preset feature



### 4 Set to Audio preset mode

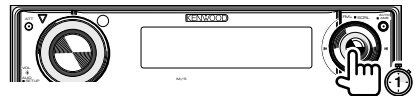

### 5 Show the memory



### 6 Memorize the audio control settings

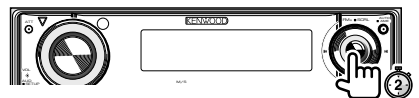

**7 Exit the audio preset mode**

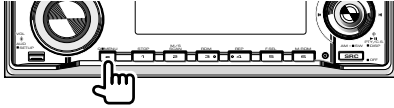

- The settings cannot be memorized by source.  
Only 1 set of audio control settings can be memorized.
- You can memorize the features in <Detailed audio control> and <Audio setup>. Note, however, that the values set for "R-VOL", "BAL", "FAD", "AVOUT" and "2ZON" will not be memorized.

**5 Recall the audio control settings**

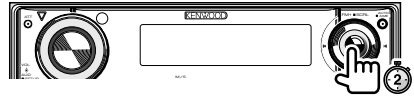

**6 Exit the audio preset mode**



- If audio preset is recalled, the values set in <Detailed audio control> and <Audio setup> will be overwritten by the memorized values.

**Recalling audio preset values**

Call the values memorized in the Audio preset memory.

**1 Select a source**



**2 Set to the menu mode**

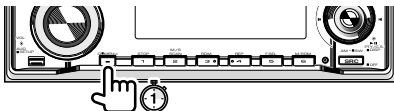

**3 Select the Audio preset feature**



**4 Set to Audio preset mode**

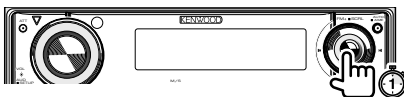

## T.I (Traffic Information)

Switches to traffic information automatically when a traffic bulletin starts even when you are not listening to the radio.

When T.I is ON, the "TI" indicator is ON. The "TI" indicator blinks while stations other than traffic information stations are received. When a traffic bulletin starts, "TRAFFIC" is displayed and the mode switches to traffic information.

### Receiving other traffic information stations

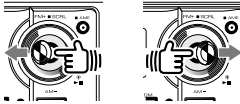

- When receiving an AM station while the Traffic Information function is turned ON, you will be switched to an FM station.
- The volume adjusted while receiving traffic information is automatically memorized and the next time traffic information is accessed, you will receive it at that set volume.



# HD Radio Control

Connecting the optional HD Radio Tuner (KTC-HR100/TR) allows you to listen to HD Radio with this unit.

## About HD Radio

- When you connect an HD Radio, the tuner features of the unit are disabled and those of the HD Radio tuner are enabled. Some setting methods including the Tuning Mode will change.
- With the HD Radio tuner, you can access functions such as <Station Preset Memory>, <Auto Memory Entry>, and <Preset Tuning> similar to the Tuner features. Refer to Tuner features for details on how to use the functions.



- The RDS function will no longer be available. Also note that the "SYNC" feature in the menu will be displayed, but will not function.

## Tuning

Selects the HD Radio station.

### 1 Select the HD Radio source

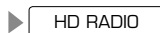
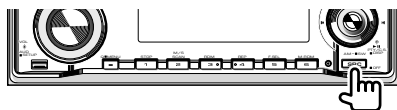

### 2 Select the HD FM band



Each time the button is pressed, the radio band switches in the following order.

Display	Band
"HF1"	HD FM 1
"HF2"	HD FM 2
"HF3"	HD FM 3

### Select the HD AM band



### 3 Select a station

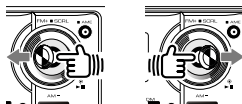

- Tune the radio to one or more stations (digital and/or analog) by using the "HDR MODE" (page 48) settings in <Menu setup> (page 48).

# Remote Controller

This unit can be operated using the Remote Controller supplied with the unit.



- Put the Remote Controller in a place where it will not move during braking or other operations. A dangerous situation could result, if the Remote Controller falls down and gets wedged under the pedals while driving.
- Do not place the battery near an open flame or heat source. This may cause the battery to explode.
- Do not recharge, short, break up or heat the battery or place it in an open fire. Such actions may cause the battery to leak fluid. If spilled fluid comes in contact with your eyes or on clothing, immediately rinse with water and consult a physician. Place the battery out of reach of children. In the unlikely event that a child swallows the battery, immediately consult a physician.

## Battery installation

Using a pen tip or similar object, open the battery compartment in Direction ② (as shown) while unfastening the lock in Direction ① (as shown). Insert the lithium battery (CR2025) supplied, making sure the polarities are correct. (See the illustration inside the battery compartment.)

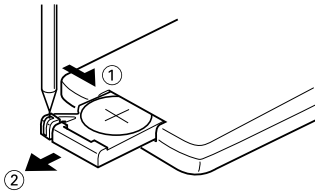

- If the Remote Controller operates only over shorter distances or does not operate at all, it is possible that the lithium battery is depleted. In such instances, replace the battery with a new one.

## Remote Controller mode switch

The functions operated from the remote controller differ depending on the position of the mode switch.



### AUD mode

Switch to this mode when controlling a selected source or a CD changer etc.

### DVD mode

Switch to this mode when playing DVDs or CDs etc. with the player integrated in this unit.



- The position of the remote control mode switch is indicated in the title of each mode, e.g., "(AUD mode)".
- When controlling a player that is not integrated in the unit, select "AUD" mode.

## Common operations (AUD mode)

### Source switching

Switches to the source to be played.



### Volume control

Adjusts the volume.



### Volume attenuator

Press the key once to lower the volume. Press again to restore the previous volume.



### Audio control

Adjusts the sound quality.

- 1 Select the feature you want to adjust.



- 2 Adjust.



- Refer to <Detailed audio control> (page 40) for information on the features that can be adjusted. However, you cannot adjust the detailed setting features such as "BAS F".

### Menu settings

Sets the menu.

- 1 Press the Menu Mode key.



- 2 Select a feature.



- 3 Adjust the feature.



- Refer to page 48 for information on the features that can be adjusted.

### Dual Zone

Switches the Dual Zone function ON and OFF.



### Rear volume control

Adjusts volume at rear when the Dual Zone function is ON.



**DVD/VCD/CD/Audio files (DVD mode)**

**Folder search**

Selects the folder to be played.



**Track search and file search**

Selects the track or file to be played.



**Play/Pause**

Pauses the track.

Press again to resume playing.



**Stop**

Memorizes the last point where the disc stopped.

When pressed again, the last point is deleted.



**Direct search**



Pressing this button switches the features that can be searched directly.

**DVD**

- \_\_\_\_\_ Title number
- \_\_\_\_\_ Chapter number
- \_\_\_\_\_ Play time
- \_\_\_\_\_ Item number\*
- \_\_\_\_\_ Cancel

\*You may not be able to use this function with some discs or scenes.

**CD**

- \_\_\_\_\_ Track number
- \_\_\_\_\_ Play time
- \_\_\_\_\_ Cancel

**Audio files**

- \_\_\_\_\_ Folder number
- \_\_\_\_\_ File number
- \_\_\_\_\_ Cancel

**VCD1.X, VCD 2.X (PBC OFF)**

- \_\_\_\_\_ Track number
- \_\_\_\_\_ Play time
- \_\_\_\_\_ Cancel

**VCD 2.X (PBC ON)**

- \_\_\_\_\_ Scene number
- \_\_\_\_\_ Number
- \_\_\_\_\_ Cancel

Once you have switched to the direct search feature, specify the search number from the numeric keypad, and then press  [ENTER] key.

## Numeric keypad



- Specify the number to search in direct search.

## Radio (AUD mode)

### Band switching

Switches to bands received by the unit.



### Station selection

Switches to broadcast stations received by the unit.



### Direct tuning

After pressing this key, use the keypad to specify the broadcast station you wish to receive.



Example: 92.1MHz (FM)



Example: 810kHz (AM)

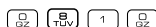

### Numeric keypad



- To use preset tuning, press the number of a programmed broadcast station. (1 - 6 MIND)
- Press the direct tuning key first, then specify the frequency of the station to receive.

## Audio files

This unit plays MP3 and WMA audio files. The following restrictions apply to the formats and discs that this unit can play. Please note that in all cases the values shown for the characters are those for one-byte characters.

### Acceptable audio files

- MP3
- WMA



- Copy protected files cannot be played.
- Playback or display may not be possible owing to encoded software settings or environments.
- It may not be possible to play files with more recent versions of compressed formatting or files with added specifications.

### Acceptable MP3 formats

This unit can play the following two MP3 file formats:

MPEG1 Audio Layer 3 and MPEG 2 Audio LSF Layer 3 standard files.

- Sampling frequencies: 32/ 44.1/ 48 kHz
- Bit rate: 32–320 kbps

### Acceptable WMA formats

This unit can play WMA files in the following formats.

- Windows Media™ Audio
- Sampling frequencies: 32/ 44.1/ 48 kHz
- Bit rate: 48–192 kbps

It is possible that when some functions of Windows Media™ Player version 9 or higher are used, normal playback will not be possible.

### Acceptable discs

- CD-R/RW/ROM
- DVD±R/RW

Discs made using simple CD-RW formats cannot be played.

### Acceptable CD-R/RW formats

This unit can play discs in the following formats.

- ISO 9660 Level 1
- ISO 9660 Level 2
- Joliet
- Romeo

Please note that file and folder names can be displayed using a maximum of 128 characters. (Includes period ".", and three-letter file extension.)

For information on characters that can be used, refer to the writing software manual or to the <File names> section below.

However, the following restrictions apply to discs this unit can play.

- Maximum directory hierarchy: 8 levels
- Maximum number of files per folder: 255
- Maximum number of folders: 254

Audio files written in formats other than those shown above may not play properly or the file and folder names may not be displayed correctly.

### Settings for compression software and writing software

It is recommended that when compressing an audio file you select the "constant" size of "128bps" for the transfer bit rate setting in the compression software. Select the "Disc at Once" setting when recording data by filling an empty disc at one time.

### File names

Please add the appropriate ".MP3" or ".WMA" extension to audio files. Files that do not have either of these extensions cannot be played.



- Do not add the above extensions to files that are not audio files. Should you add one of these extensions, the unit will mistakenly recognize the file as an audio file, thus producing a loud noise that could damage the speakers.

### Display of track information for audio files

This unit can display the following track information: track name, artist name and album name.

Information is displayed using Roman letters and Arabic numerals.

- Track information recorded using v1.0, 1.1 or 2.3 standards for the MP3 ID3 Tag is displayed using a maximum of 30 characters.
- WMA content properties are displayed using a maximum of 30 characters.

## Order for playing audio files

The order in which files or folders are selected using Playback, Folder Search, File Search and Folder Select is the order written into the writing software. As a result, there may be occasions when the order in which you expect tracks to play does not correspond to the actual order in which they play.

Although it depends on your PC environment, it is possible to set the playing order by specifying using numbers "01" through "99" at the beginning of file names and writing them into a CD-R or CD-RW disc etc.

When using discs with folder and file levels like that shown below, the following occurs when conducting a Folder Search or File Search or when selecting a folder.

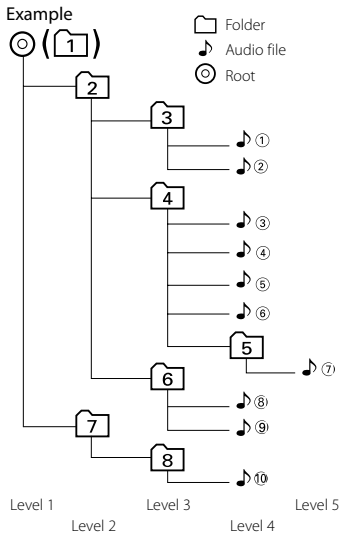

## Performing a File Search during playback...

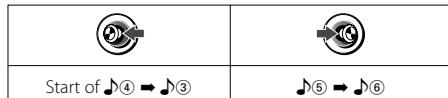

## When performing Folder Search during playback...



## When performing File Select during playback...



## When performing Folder Select 1 during playback...

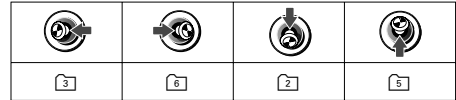

## When performing Folder Select 2 during playback...



### Video files

This unit can play MPEG video files. The following restrictions apply to the formats and discs that this unit can play.

#### Acceptable video files

- Format: MPEG1, MPEG2
- Picture size:
  - MPEG1: 320 × 240, 352 × 240
  - MPEG2: 640 × 480, 704 × 480
- Audio format: MPEG Audio Layer 2
- Audio sampling frequencies: 32/ 44.1/ 48 kHz
- Audio bit rate: 32–384 kbps (Only constant bit rates)

#### Acceptable discs

- DVD±R/RW

#### Extensions

Video files must have one of the following extensions:

mpg, mpeg, mpe, m1v, m2v

Disc formats, file and folder names and playing order are the same as those for audio files. Refer to <Audio files> (page 62).

### Picture files

This unit can play JPEG files. The following restrictions apply to the formats and discs that this unit can play.

#### Acceptable picture files

- Format: JPEG
- Baseline format:
  - Up to a maximum of 5120(W) × 3840(H) pixels
- Progressive format:
  - Up to a maximum of 2048(W) × 1536(H) pixels



- Enlarges and reduces images up to the size shown above to fit to the screen.
- The picture files with information attached (such as Exif) may not be displayed or operated (e.g.: rotation display) properly.

#### Extensions

Picture files must have one of the following extensions:

jpg, jpeg, jpe, jfif

Acceptable discs, disc formats, file and folder names and playing order are the same as those for audio files. Refer to <Audio files> (page 62).



## General

### ? The power does not turn ON.

- ✓ The fuse has blown.
- ✘ After checking for short circuits in the wires, replace the fuse with one with the same rating.

- ✓ The speaker wire has a short-circuit or touches the chassis of the vehicle, and then the protection function is activated.
- ✘ Wire or insulate the speaker cable properly and press the Reset button.

- ✓ A security code has been set.
- ✘ Enter the set security code (page 51).

### ? No sound can be heard, or the volume is low.

- ✓ The fader or balance settings are set all the way to one side.
- ✘ Center the fader and balance settings.

- ✓ The "AMP" feature in Menu setup is "OFF".
- ✘ Turn the "AMP" feature "ON", referring to <Menu setup> section (page 48).

- ✓ The values for Volume offset are too low.
- ✘ Turn up the Volume offset, referring to the <Audio setup> section (page 40).
- ✓ The input/output wires or wiring harness are connected incorrectly.
- ✘ Reconnect the input/output wires or the wiring harness correctly. Refer to the <Connections> section (page 74).

### ? The sound quality is poor or distorted.

- ✓ One of the speaker wires is being pinched by a screw in the car.
- ✘ Check the speaker wiring.
- ✓ The speakers are not wired correctly.
- ✘ Reconnect the speaker wires so that each output terminal is connected to a different speaker.

### ? The TEL mute function does not work.

- ✓ The TEL mute wire is not connected properly.
- ✘ Connect the wire correctly, referring to the <Connections> section (page 74).

### ? The TEL mute function turns ON even though the TEL mute wire is not connected.

- ✓ The TEL mute wire is touching a metal part of the car.
- ✘ Pull the TEL mute wire away from the metal part of the car.

### ? The memory is erased when the ignition is turned OFF.

- ✓ The ignition and battery wire are incorrectly connected.
- ✘ Connect the wire correctly, referring to the <Connections> section (page 74).

### ? There is no loudness effect.

- ✓ You are using Subwoofer preout.
- ✘ Loudness has no effect in Subwoofer preout.

### ? Even if Loudness is turned ON, high-pitched tone is not compensated for.

- ✓ Tuner source is selected.
- ✘ High-pitched tone is not compensated for when in Tuner source.

### ? Radio reception is poor.

- ✓ The car antenna is not extended.
- ✘ Pull the antenna out all the way.
- ✓ The antenna control wire is not connected.
- ✘ Connect the wire correctly, referring to the <Connections> section (page 74).

### ? There is a source you cannot switch.

- ✓ The Disc changer is not connected.
- ✘ Connect the Disc changer. If the Disc changer is not connected to its input terminal, you cannot switch to an external disc source.

### ? The display blacks out while scrolling.

- ✓ The "DISP" feature under <Menu setup> is "OFF".
- ✘ Turn the "DISP" feature "ON", referring to the <Menu setup> section (page 48).

**? Even though Synchronize Clock is ON, the clock cannot be adjusted.**

- ✓ The received RDS station is not sending time data.
- ✘ Receive another RDS station.

**? The Dimmer function does not work.**

- ✓ The Dimmer wire is not connected correctly.
- ✘ Check the Dimmer wire connection.
- ✓ The "DIM" feature in the <Menu setup> is set to "OFF".
- ✘ Turn the "DIM" feature "ON", referring to the <Menu setup> section (page 48).

**? Cannot set Dual Zone System of <Audio Setup> (page 40).**

- ✓ CA-C1AX/ CA-C2AX is connected to KCA-S220A or other units.
- ✘ Connect the CA-C1AX/ CA-C2AX directly to this unit.

## Playing discs

**? Cannot insert disc.**

- ✓ There is already another disc inserted.
- ✘ Remove the inserted disc and insert the disc you want to play.

**? A disc ejects as soon as it is loaded.**

- ✓ The disc is quite dirty.
- ✘ Clean the disc, refer to <Disc cleaning> in the <Handling media> section (page 11).

**? Cannot remove disc.**

- ✓ Disc stops while being ejected.
- ✘ Continue to push the Eject button until the disc is ejected completely.
- ✓ The cause is that more than 10 minutes have elapsed since the vehicle ACC switch was turned OFF.
- ✘ The disc can only be removed within 10 minutes of the ACC switch being turned OFF. If more than 10 minutes have elapsed, turn the ACC switch ON again and press the Eject button.
- ✓ A disc whose validity date is expired is loaded.
- ✘ Turn the power OFF, and wait for 15 seconds before pressing [▲] (Eject) button.

**? The specified disc does not play, but another one plays instead.**

- ✓ The specified disc is quite dirty.
- ✘ Clean the disc.
- ✓ The disc is loaded in a different slot from that specified.
- ✘ Eject the disc magazine and check the number for the specified disc.
- ✓ The disc is severely scratched.
- ✘ Try another disc instead.

**? Direct Search does not work.**

- ✓ Another function is ON.
- ✘ Turn Random Play or other functions OFF.

**? Cannot select soundtrack language, subtitle language or angles, or the disc does not play in the specified language.**

- ✓ Multiple languages or angles have not been included.
- ✘ It may be possible to select these using the Menu. Refer to the disc's instruction leaflet.

**? The VCD Menu (Playback Control) is not displayed**

- ✓ Playback Control has not been included in the VCD.
- ✘ Refer to the disc's instruction leaflet.

## Audio files

**? Cannot play an Audio file.**

**? The sound skips when an Audio file is being played.**

- ✓ The recording condition is bad.
  - ✘ Record the media again or use another media.
- 
- ✓ The media is scratched or dirty.
  - ✘ Clean the disc, refer to <Disc cleaning> in the <Handling media> section (page 11).

**? The Audio file track time is not displayed correctly.**

- ✓ --
- ✘ There are times when it is not displayed correctly depending on the recording conditions of the Audio file.

## HD Radio source

**? No sound can be heard, or the volume is low.**

- ✓ The preset broadcast station is not transmitting in the mode that was set with <HD Radio Receive mode Setting> (page 52).
  - ✘ Please set <HD Radio Receive mode Setting> to "AUTO".
- 
- ✓ In digital AM broadcasting, receive mode switches between stereo and monaural too often.
  - ✘ Receiving condition is bad or unstable. Stereo is chosen when receiving condition is good, and it switches to monaural when the condition becomes bad.
- 
- ✓ HD Radio tuner is connected to KCA-S220A or other units.
  - ✘ Connect the HD Radio tuner directly to this unit.

## Menu

**? The Security Code feature is not displayed.**

- ✓ The "DEMO" feature in <Menu setup> is "ON".
  - ✘ Turn the "DEMO" feature "OFF", referring to the <Demonstration setup> section (page 54).
- 
- ✓ A security code has already been set.
  - ✘ When the Security Code is initially set, "CODE SET" changes to "CODE CLR".

**? The display's brightness level does not change.**

- ✓ The car's light switch is OFF.
  - ✘ Turn ON the car's light switch.
- 
- ✓ The illumination cord has not been connected.
  - ✘ Connect the cord correctly, referring to the <Connections> section (page 74).

## General

### MP3

MP3 is an abbreviation for "MPEG Audio Layer 3". MPEG Audio is the compression standard for only the audio portion of image compression methods used for DVDs and Video CDs.

This manual sometimes specifies audio files that use this method.

For information on formats and the kinds of MP3 recorded discs that can be used, refer to the <Audio files> section under Help? (page 62).

### WMA (Windows Media™ Audio)

WMA is the abbreviation for the Windows Media™ Audio system of audio compression encoding developed by Microsoft Corporation.

This manual sometimes specifies audio files that use this method.

For information on formats and the kinds of WMA recorded media that can be used, refer to the <Audio files> section under Help? (page 62).

### Disc changer

These are either externally connected optional CD changers (KDC-CX87, KDC-C719, KDC-C669, etc) or a multimedia player (KDV-C810, KDV-C840).

## Audio control

### R-VOL (Rear volume)

Controls volume at the rear when the Dual Zone function is in use.

### SW L (Subwoofer volume)

Controls the volume of the subwoofer.

### HPF/HPR (High Pass Filter)

A high pass filter cuts out frequencies lower than the cutoff frequency.

When preamp output is used as a subwoofer, this function is used to cut out low frequencies from the output and produce only high frequencies. This function can be disabled by turning on the "THRU" setting.

This unit is equipped with two high pass filters, one in the front speaker (HPF) and one in the rear speaker (HPR).

### LPF (Low pass filter)

A low pass filter cuts out frequencies higher than the cutoff frequency.

When preamp output is used as a subwoofer, this function is used to cut out high frequencies from the output and produce only low frequencies. This function can be disabled by turning on the "THRU" setting.

### PHAS (Subwoofer phase)

Sets the phase of the subwoofer (positive phase or reverse phase).

### V-OFF (Volume offset)

Controls the differences in the volumes of each source. As a result, even when switching to a different source the volume of the sound you hear will be more or less the same.

### AVOUT (AV out level)

Sets the signal level for audio output from the AV OUT terminal.

### 2ZON (Dual zone)

The dual zone function splits the output of the main source and sub source between the front speaker and rear speaker.

OFF : Dual zone function is off.

DVD : DVD is set as the sub source.

AUX : Sub source is set to AUX.

- Output destination of sub source is specified using "ZONE2" in the <Menu setup> section (page 48).
- The main source is specified using <Changes a source> (page 13).
- Front speaker volume is adjusted using the [VOL] button.
- Rear speaker volume is adjusted by "R-VOL" in the <Detailed audio control> section (page 40) or by using the [R.VOL] key (page 59) on the remote control.

## Menu

### AMP (Built-in amp output)

Output from the built-in amp is turned ON and OFF. When there is a system where power amps are connected to the preamp output terminals of both the front speaker and the rear speaker, operation of the built-in amp can be stopped by turning this function "OFF".

The quality of audio output from the preamp outputs can be improved by stopping operation of the built-in amp.

### BEEP (Beeping)

This function produces a beeping sound when pressing a button to confirm that the button has been pressed.

If you find this beeping sound annoying, you can get rid of it by turning it "OFF".

Please note that this beeping sound does not come out of preamp outputs.

### CD READ (Reading a CD)

Specifies the method for reading a CD. When a specially formatted CD does not play properly, specifying "2" will make the CD play. Please note that even after selecting "2", it will not be possible to play some music CDs. Also, if you set it to "2", you cannot play audio or picture files. Under normal circumstances, set at "1".

1 : It automatically distinguishes between a disc with audio files/picture files and a music CD during playing the disc.

2 : It overrides to play the disc as a CD.

### CODE SET/CODE CLR (Setting security code/ Clearing security code)

Sets and cancels the security code. Once a security code has been set, when the unit is used for the first time after the unit has been unplugged, the unit's power cord has been disconnected or the Reset button has been pushed, the power will not turn on unless you enter the set security code. In other words, this function helps prevent theft as the security code must be entered after the unit has been removed from the vehicle.

### CRSC (Clean Reception System Circuit)

Temporarily have reception alternate from stereo to mono to reduce multi-path noise when listening to an FM station.

Strong electrical fields (such as from power lines) may cause unstable sound quality when CRSC is turned ON. In such a situation, turn it OFF.

### DIM (Dimmer)

Display brightness automatically switches on in conjunction with the vehicle light switch.

### DISP

When set at the "OFF" position, the display disappears if the unit is not operated for a period of five seconds. This prevents the display from being reflected in the vehicle's windows.

However, if any of the modes have been set the display will not disappear even after five seconds.

When the display is off, pressing any buttons will return the display.

Please note that when the display disappears, the only operations that can be performed are turning the power ON and OFF, adjusting volume, selecting a source and ejecting a disc.

### DSI (Disabled system indicator)

Turns the security indicator ON and OFF.

When this function is ON and the panel has been removed, the LED for the [▲] (Eject) button flashes so that it functions as a theft prevention warning light.

### KEY (Button illumination)

You can choose green or red for illuminating the buttons.

### SCL (Scrolling)

In cases where there are too many characters to display all the information when selecting disc or track titles, disc or track text, group titles, folder names, file names, track names and artist names or album names on the display, use this function to scroll down so that all the information is displayed.

When this function is set at "AUTO" the display scrolls repeatedly. When it is set at "MANU" the display scrolls once only when the display changes.

### ▼ **SWPRE (Switchable preout)**

This function sets audio to be output by the preamp output terminal.

SW : Outputs audio used by the subwoofer.

AV : Outputs audio not affected by audio controls. Is set when connected to a rear monitor.

### **SYNC (Synchronize Clock)**

Synchronizes time data sent from an RDS station with the unit's built-in clock.

Synchronization takes 3 to 4 minutes.

### **M/V (Macrovision Version)**

Displays the version of copyright protection technology used in a DVD.

### **ZONE2**

Sets the output destination (front speakers or rear speakers) of the sub source when the dual zone function is ON.

---

## When the unit fails to operate correctly, the cause of the failure appears on the display.

---

### TOC ERR/READ ERR :

- Disc is unusually dirty.
  - Disc has many scratches.
  - Disc is upside down.
  - The tray is not in the disc changer.
  - There is no disc in the disc changer.
- 

### E-05 :

Disc is upside down.

---

### E-15 :

The disc you want to play does not include files that can be played by this unit.

---

### EJECT :

- Disc magazine has not been set.
  - Disc magazine is not completely inserted.
  - No disc is loaded in this unit.
  - Etc
- 

### NO DISC :

Disc magazine does not contain even a single disc.

---

### REG ERR :

The disc you wanted to play has a region code that cannot be played with this unit.

---

### PAR ERR:

The disc you wanted to play has a higher level than the parental level you set.

---

## The following messages appear to inform you of the status of the system.

---

### PRK OFF :

Source for displaying video is selected while car is traveling.

- ➔ Video will be displayed when the car is stopped and the parking brake has been engaged.
- 

### CODE ---- :

Request to enter security code.

---

### E-07-67/ E-77 :

Is not operating correctly due to some reason or other.

- ➔ Push the unit's Reset button. If the "E-07-67"/ "E-77" message does not disappear, see your nearest Kenwood dealer.
- 

### HOT ERR :

When the internal temperature of this unit rises to 60°C or more, the protection circuit is activated and you may not be able to operate the unit. At such times this message will appear.

- ➔ Use the unit again after reducing the temperature inside the vehicle.
- 

### HOLD :

Activation of the protective circuit when the temperature inside the disc changer is higher than 60 degrees Celsius stops the disc changer from operating. At such times this message will appear.

- ➔ Use when the temperature at the site where the disc changer has been fitted has dropped.
- 

### [IN] indicator flashes :

DVD player is not operating correctly.

- ➔ Remove the Disc and insert it again.
- 

### E-09/ E-19/ E-99 :

Is not operating correctly due to some reason or other.

- ➔ Press the [▲] (Eject) button. If the message does not disappear even after pushing the Eject button, push the unit's Reset button. If the message still does not disappear, contact your nearest Kenwood dealer.
- 

### LOAD (Flashes) :

Discs are currently being changed inside the disc changer.

---

### READING (Flashes) :

Data on the disc is currently being checked.

---

### PROTECT (Flashes) :

Protective circuit has been activated because a speaker cord has shorted or it has come in contact with the car chassis.

- ➔ Wire or insulate the speaker cord as appropriate and then push the Reset button.
- 

### DEMO MODE :

The unit is currently in Demonstration mode. This mode shows the unit's functions on the display. To cancel turn the Demonstration mode OFF.

---

# DVD language codes

Code	Language
aa	Afar
ab	Abkhazian
af	Afrikaans
am	Amharic
ar	Arabic
as	Assamese
ay	Aymara
az	Azerbaijani
ba	Bashkir
be	Byelorussian
bg	Bulgarian
bh	Bihari
bi	Bislama
bn	Bengali, Bangla
bo	Tibetan
br	Breton
ca	Catalan
co	Corsican
cs	Czech
cy	Welsh
da	Danish
de	German
dz	Bhutani
el	Greek
en	English
eo	Esperanto
es	Spanish
et	Estonian
eu	Basque
fa	Persian
fi	Finnish
fj	Fiji
fo	Faroese
fr	French
fy	Frisian
ga	Irish
gd	Scots Gaelic
gli	Galician
gn	Guarani
gu	Gujarati
ha	Hausa
he	Hebrew
hi	Hindi
hr	Croatian
hu	Hungarian
hy	Armenian
ia	Interlingua
ie	Interlingue
ik	Inupiak
id	Indonesian







Code	Language
is	Icelandic
it	Italian
ja	Japanese
jv	Javanese
ka	Georgian
kk	Kazakh
kl	Greenlandic
km	Cambodian
kn	Kannada
ko	Korean
ks	Kashmiri
ku	Kurdish
ky	Kirghiz
la	Latin
lb	Luxembourgish
ln	Lingala
lo	Laotian
lt	Lithuanian
lv	Latvian, Lettish
mg	Malagasy
mi	Maori
mk	Macedonian
ml	Malayalam
mn	Mongolian
mo	Moldavian
mr	Marathi
ms	Malay
mt	Maltese
my	Burmese
na	Nauru
ne	Nepali
nl	Dutch
no	Norwegian
oc	Occitan
om	(Afan) Oromo
or	Oriya
pa	Punjabi
pl	Polish
ps	Pashto, Pushto
pt	Portuguese
qu	Quechua
rm	Rhaeto-Romance
rn	Kirundi
ro	Romanian
ru	Russian
rw	Kinyarwanda
sa	Sanskrit
sd	Sindhi
sg	Sangho
sh	Serbo-Croatian

Code	Language
si	Singhalese
sk	Slovak
sl	Slovenian
sm	Samoan
sn	Shona
so	Somali
sq	Albanian
sr	Serbian
ss	Siswati
st	Sesotho
su	Sundanese
sv	Swedish
sw	Swahili
ta	Tamil
te	Telugu
tg	Tajik
th	Thai
ti	Tigrinya
tk	Turkmen
tl	Tagalog
tn	Setswana
to	Tongan
tr	Turkish
ts	Tsonga
tt	Tatar
tw	Twi
uk	Ukrainian
ur	Urdu
uz	Uzbek
vi	Vietnamese
vo	Volapuk
wo	Wolof
xh	Xhosa
yo	Yoruba
zh	Chinese
zu	Zulu

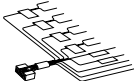

# Accessories/ Installation Procedure

## Accessories

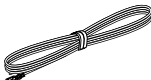
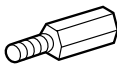
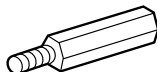
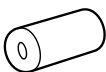
①		.....1
②		.....2
③		.....4
④		.....4
⑤		.....2
⑥		.....1
⑦		.....1
⑧		.....1
⑨		.....1
⑩		.....1
⑪		.....1

## Installation Procedure

1. To prevent a short circuit, remove the key from the ignition and disconnect the ⊖ battery.
2. Make the proper input and output wire connections for each unit.
3. Connect the speaker wires of the wiring harness.
4. Connect the wiring harness wires in the following order: ground, battery, ignition.
5. Connect the wiring harness connector to the unit.
6. Install the unit in your car.
7. Reconnect the ⊖ battery.
8. Press the Reset button.

### ▲WARNING

If you connect the ignition wire (red) and the battery wire (yellow) to the car chassis (ground), you may cause a short circuit, that in turn may start a fire. Always connect those wires to the power source running through the fuse box.



- If the power is not turned ON (or it is ON, but will be OFF immediately), the speaker wire may have a short-circuit or touched the chassis of the vehicle and the protection function may have been activated. Therefore, the speaker wire should be checked.
- If your car's ignition does not have an ACC position, connect the ignition wires to a power source that can be turned on and off with the ignition key. If you connect the ignition wire to a power source with a constant voltage supply, as with battery wires, the battery may die.
- If the console has a lid, make sure to install the unit so that the faceplate will not hit the lid when closing and opening.
- If the fuse blows, first make sure the wires aren't touching to cause a short circuit, then replace the old fuse with one with the same rating.
- Insulate unconnected wires with vinyl tape or other similar material. To prevent a short circuit, do not remove the caps on the ends of the unconnected wires or the terminals.
- Connect the speaker wires correctly to the terminals to which they correspond. The unit may be damaged or fail to work if you share the ⊖ wires or ground them to any metal part in the car.
- When only two speakers are being connected to the system, connect the connectors either to both the front output terminals or to both the rear output terminals (do not mix front and rear). For example, if you connect the ⊕ connector of the left speaker to a front output terminal, do not connect the ⊖ connector to a rear output terminal.
- After the unit is installed, check whether the brake lamps, blinkers, wipers, etc. on the car are working properly.
- Mount the unit so that the mounting angle is 30° or less.

# Connections

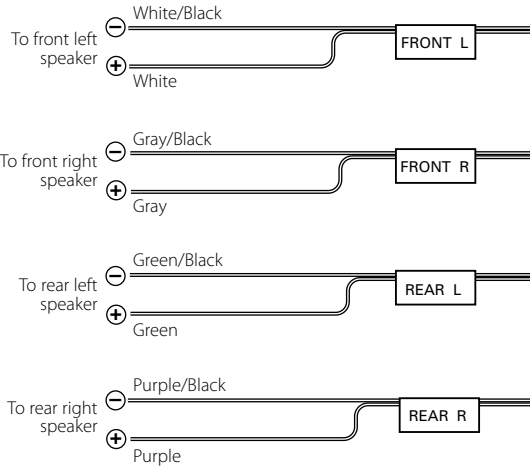
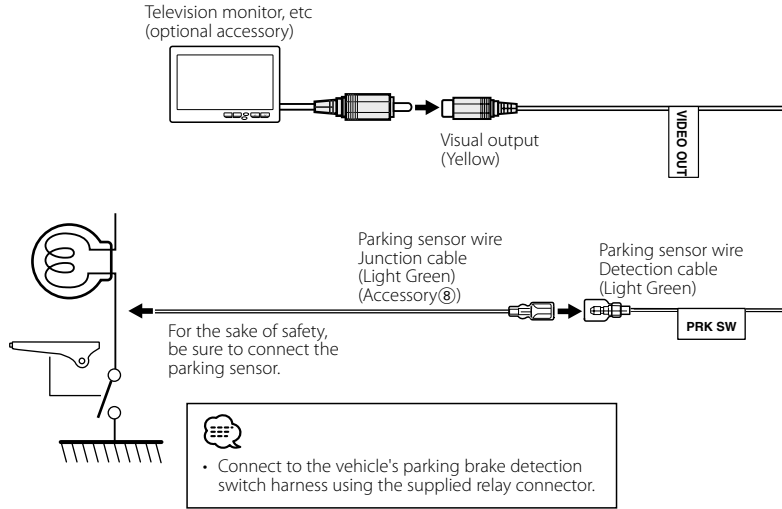

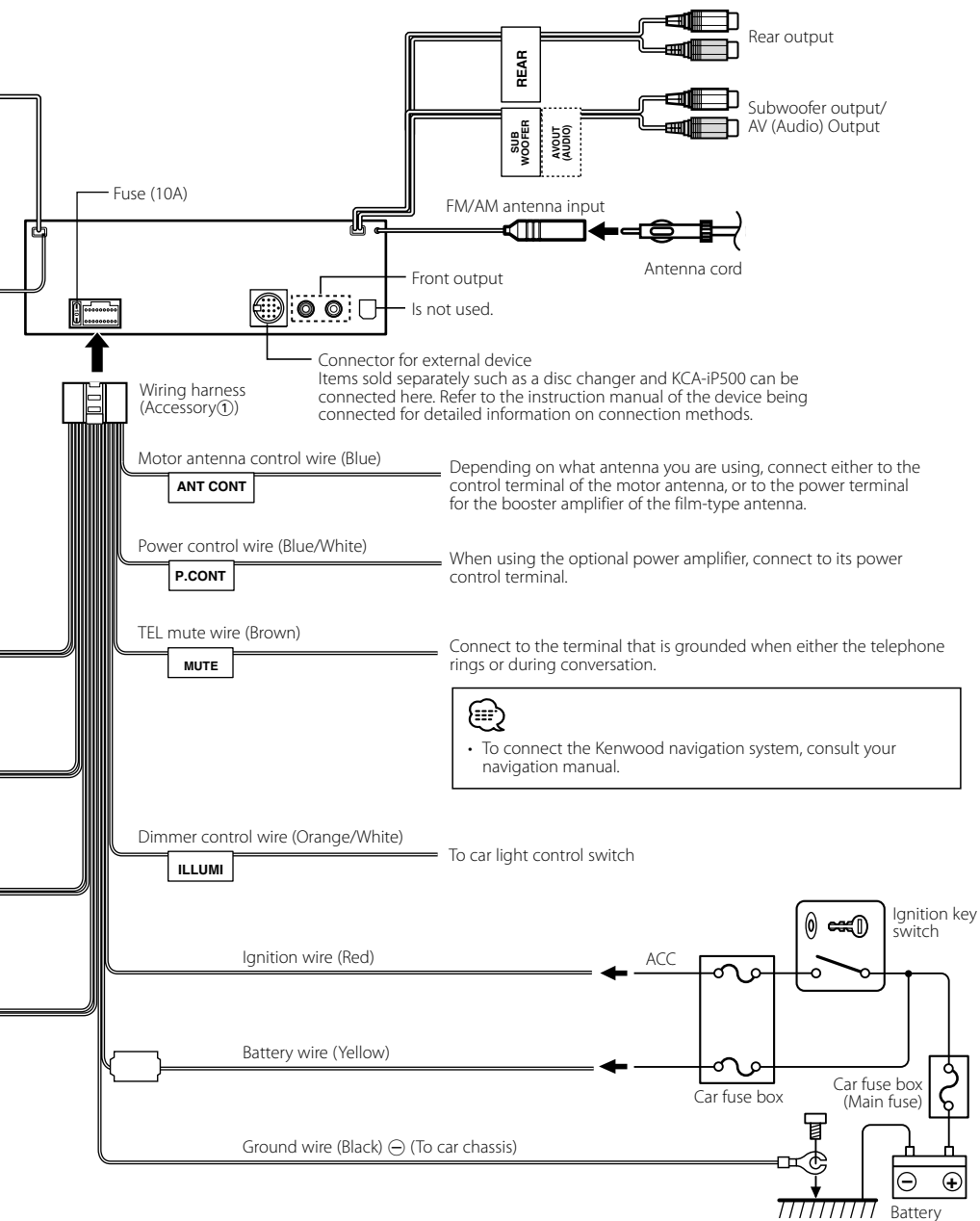

# Installation

## Non-Japanese cars

Bend the tabs of the mounting sleeve with a screwdriver or similar utensil and attach it in place.

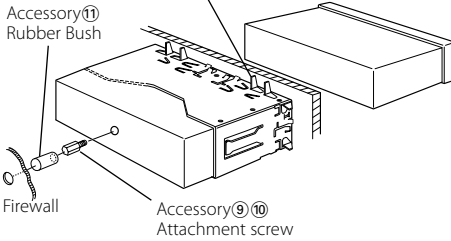

• When the space between the unit and Firewall is narrow

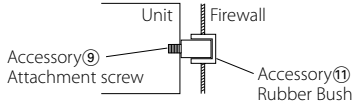

• When the space between the unit and Firewall is wide

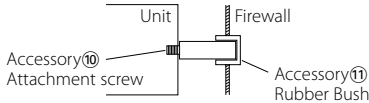

• Make sure that the unit is installed securely in place. If the unit is unstable, it may malfunction (for example, the sound may skip).

## Japanese cars

1 Refer to the section <Removing the hard rubber frame> (page 77) and then remove the hard rubber frame.

2 Align the holes in the unit (two locations on each side) with the vehicle mounting bracket and secure the unit with the accessory screws.

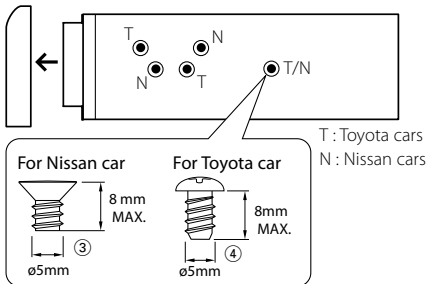

- During installation, do not use any screws except for those provided. The use of different screws might result in damage to the main unit.
- Damage may occur if a screwdriver or similar tool is used with excessive force during the installations.

## Screwing the Faceplate on the Unit

If you want to fasten the faceplate to the main unit so that it does not fall off.

1 Refer to the section <Removing the hard rubber frame> (page 77) and then remove the hard rubber frame.

2 Drop open the faceplate by pressing the Release button.

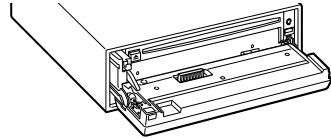

3 Tighten the screw (ø2 × 5 mm) (Accessory 5) and bracket (Accessory 6) in the hole shown on the diagram.

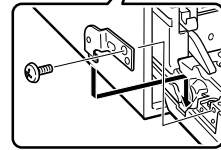
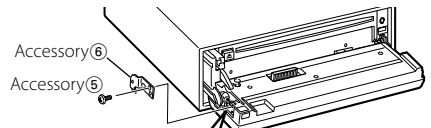

4 Tighten the screw (ø2 × 5 mm) (Accessory 5) and bracket (Accessory 7) in the hole shown on the diagram.

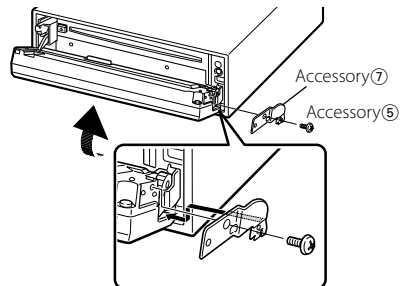



- Never insert the screws in any other screw hole than the one specified. If you screw them in another hole, it will contact and may cause damage to the mechanical parts inside the unit.

## Removing the hard rubber frame

- 1 Engage the catch pins on the removal tool and remove the two locks on the upper level. Upper the frame and pull it forward as shown in the figure.

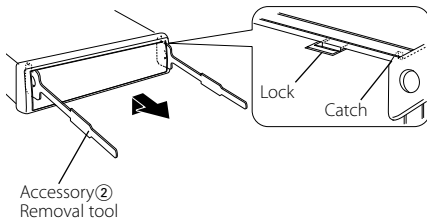

- 2 When the upper level is removed, remove the lower two locations.

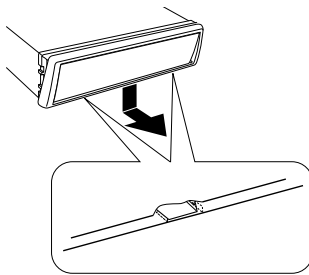

- The frame can be removed from the bottom side in the same manner.

## Removing the Unit

- 1 Refer to the section <Removing the hard rubber frame> (page 77) and then remove the hard rubber frame.
- 2 Remove the screw (M4 × 8) on the back panel.
- 3 Insert the two removal tools deeply into the slots on each side, as shown.

Screw (M4×8)  
(commercially available)

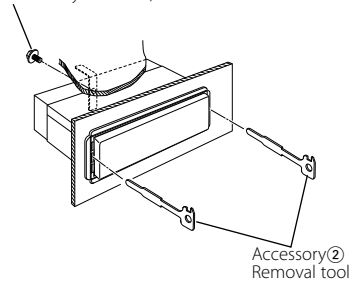

- 4 Lower the removal tool toward the bottom, and pull out the unit halfway while pressing towards the inside.

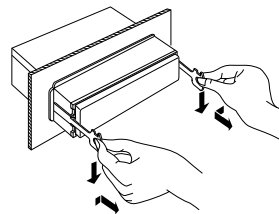

- Be careful to avoid injury from the catch pins on the removal tool.

- 5 Pull the unit all the way out with your hands, being careful not to drop it.

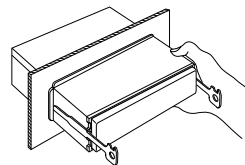

# Specifications

## FM tuner section

Frequency Range (200 kHz)

: 87.9 MHz – 107.9 MHz

Usable Sensitivity (S/N : 30 dB)

: 9.3 dBf (0.8  $\mu$ V/75  $\Omega$ )

Quieting Sensitivity (S/N : 50 dB)

: 15.2 dBf (1.6  $\mu$ V/75  $\Omega$ )

Frequency Response ( $\pm$  3.0 dB)

: 30 Hz – 15 kHz

S/N

: 70 dB (MONO)

Selectivity ( $\pm$  400 kHz)

:  $\geq$  80 dB

Stereo Separation

: 40 dB (1 kHz)

## AM tuner section

Frequency Range (10 kHz)

: 530 kHz – 1700 kHz

Usable Sensitivity (S/N : 20dB)

: 28 dB $\mu$  (25  $\mu$ v)

## DVD player section

D/A Converter

: 24 bit

Decoder

: Linear PCM/ Dolby Digital/ dts/ MP3/ WMA

Wow & Flutter

: Below Measurable Limit

Frequency Response

Sampling frequency; 96 kHz : 20 – 44,000 Hz

Sampling frequency; 48 kHz : 20 – 22,000 Hz

Sampling frequency; 44.1 kHz : 20 – 20,000 Hz

Total Harmonic Distortion

: 0.008 % (1 kHz)

S/N Ratio (dB)

: 100 dB (1 kHz)

Dynamic Range

: 96 dB

Sampling frequency

: 32/ 44.1/ 48/ 96 kHz

Quantifying bit number

: 16/ 20/ 24 bit

MP3 Decode

: Compliant with MPEG-1/2 Audio Layer-3

WMA Decode

: Compliant with Windows Media Audio

## Audio section

### Preout Level/Load

: 4000 mV/10 k $\Omega$  (CD/CD-CH)

### Video Out Level/Load

: 1 V<sub>p-p</sub>/75  $\Omega$

### Preout Impedance

:  $\leq$  600  $\Omega$

### Speaker Impedance

: 4 – 8  $\Omega$

### Maximum output power

: 50 W  $\times$  4

### Full Bandwidth Power (at less than 1% THD)

: 22 W  $\times$  4

### Tone action

Bass : 100 Hz  $\pm$  8 dB

Middle : 1 kHz  $\pm$  8 dB

Treble : 10 kHz  $\pm$  8 dB

## General

### Operating voltage

: 14.4 V (11 – 16 V allowable)

### Current Consumption

: 10 A

### Installation Size (W $\times$ H $\times$ D)

: 182  $\times$  53  $\times$  155 mm

7-3/16  $\times$  2-1/16  $\times$  6-1/8 inch

### Weight

: 1.4 kg (3.1 lbs)

---

**KENWOOD**